

SHORT WAVE RADIO

October
1934



Edited by

Robert Hertzberg and Louis Martin

IN THIS ISSUE:

Sun Spots and Radio
Reception

VK2ME, VK3ME—Voices
of Australia

Welcome Receiver Changes
By Robert S. Kruse

A New Converter Using
Regeneration
By Jay C. Boyd

Putting the 12A7 to Work
By T. C. Van Alstyne

Foreign Station Data
By J. B. L. Hinds

Complete Index to Volume I

Short - Wave CONVERTERS



for the
Broadcast Receiver

25¢
IN CANADA
30¢

BOOKS FOR THE RADIO MAN

Many of the questions asked daily by radio experimenters, constructors and listeners all over the country are answered completely and clearly in various books. To assist radio men in buying books best suited for their own particular needs, we have made a selection of representative works that we can recommend very highly. These books are all up-to-date and will prove very valuable.

“THE RADIO AMATEUR’S HANDBOOK”

238 Pages of Data

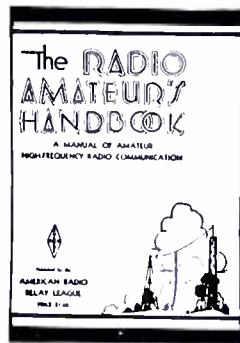

Price \$1.00 postpaid

The RADIO AMATEUR'S HANDBOOK was first published in the fall of 1926. It was in response to a growing demand upon the American Radio Relay League for some sort of a manual of operation for short-wave experimental radio work. The first edition met with great favor and two reprintings were necessary to supply the demand. Since that time ten subsequent editions have been published and more than 215,000 copies have been sold.

The latest edition (11th edition, published January, 1934) is approximately 15% larger than the first edition, and represents probably the most compre-

hensive revision yet attempted. New receiver circuits and designs are presented, together with a thorough treatment of the recently-developed “single-signal” sets. A completely re-written 36-page chapter is devoted to all that is new in the world of transmitters. New circuits and layouts are given, all problems which face the transmitting amateur being discussed in a lucid and comprehensive manner. The radio telephony chapter represents all new material. New designs for Class B modulators and speech amplifiers are featured. Still another new chapter is that on antennas.

“HOW TO BECOME A RADIO AMATEUR”

Completely done over in 1934 style, telling all about amateur radio and describing the latest equipment—push-pull transmitter—bandspread pentode receiver—simplest of monitors.

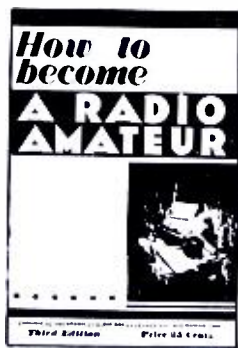

The third edition of “How to Become a Radio Amateur” marks another milestone in amateur development. Still the standard elementary guide for the would-be amateur, the simple, inexpensive station described incorporates features which in the past have been confined to the more advanced layouts. The designs have been made flexible, so that parts out of the junk box can be readily substituted. The performance of the completed station is such that any amateur can own and operate it with satisfaction and pleasure. It's a real amateur station, with construction and operation described in clear, understandable language.

Price \$.25 Postpaid

“RADIO AMATEUR'S LICENSE MANUAL”

Before you can operate an amateur transmitter, you must have a government license and an officially assigned call. These cost nothing—but you must be able to pass the examination. The License Manual tells how to do that—tells what you must do and how to do it. It makes a simple and comparatively easy task of what otherwise might seem difficult. In addition to a large amount of general information, it contains 198 typical questions and answers such as are asked in the government examinations. If you know the answers to the questions in this book, you can pass the examination without trouble.

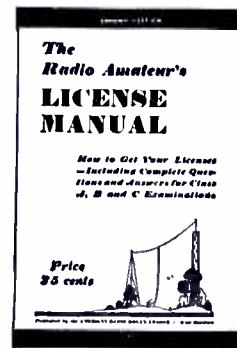

Price \$.25 Postpaid

The safest way to remit money is by post office or express money order. Hold your receipt until your books arrive. Do not send coins through the mail. Write or print your name and address clearly. Prompt deliveries of all orders guaranteed. No books sent on approval or C. O. D.

Standard Publications, Inc., 192 Lexington Ave., New York, N. Y.

I will send you a Lesson Free



to show how easy it is
to learn at home in
spare time to fill a

Good Radio Job

J. E. SMITH, President, National Radio Institute, Washington, D. C. — the man who has directed the training of more men for the Radio industry than any other man in America.



SET SERVICING has paid many N.R.I. men \$5, \$10, \$15 a week extra for their spare time. Full time men make as much as \$40, \$60, \$75 a week.

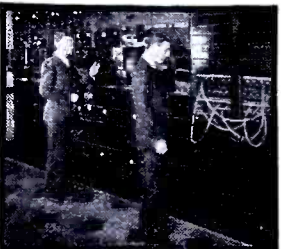

BROADCASTING STATIONS employ many technically trained men for interesting, fascinating jobs paying up to \$100 a week.

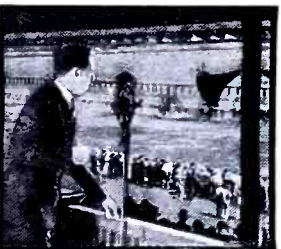

LOUD SPEAKER SYSTEMS, one of Radio's newest developments, gives interesting, well-paying jobs to many.

Clip and mail the coupon, I'll send you a FREE lesson. I'll show you that Radio is fascinating; that I give you practical money-making information, easy to learn, easy to put into use. See for yourself why many men with less than a grammar school education and no Radio experience have become Radio experts at two and three times what they were making before they enrolled with me. Get the facts about Radio's spare time and full time job opportunities.

Many Radio Experts make \$40, \$60, \$75 a week.
Get ready for Jobs like these

Broadcasting stations employ engineers, operators, managers, and men for other jobs that pay up to \$5,000 a year. Radio factories employ testers, inspectors, foremen, engineers, servicemen, salesmen, buyers, and pay up to \$7,500 a year. Radio dealers and jobbers employ servicemen, salesmen, buyers, managers, and pay up to \$100 a week. There are many opportunities to have a spare time or full time service or retail Radio business of your own. Radio business is picking up. It's a big business—big enough to absorb many more well trained men—growing bigger all the time. Get ready for Radio. Be a Radio Expert. I'll train you at home in spare time.

Many make \$5, \$10, \$15 a week Extra in Spare Time almost at once

Nearly every neighborhood needs a good spare time serviceman. Find out how I help you cash in—how I send you directions, the day you enroll, for doing 28 Radio jobs. How, when you get underway, I send you much more information for servicing sets and for doing other spare time jobs for extra money. Many make \$200 to \$1,000 while learning.

Short Wave, Loud Speaker Systems, Television, Auto Radio, etc., included

Radio is growing. Loud speaker systems, police, auto and aviation Radio, are recent new uses that have been found for it. Television promises many good jobs soon. Here is a field with a future. Get full information about it—how I train you at home in spare time to be a Radio Expert. My 50-50 method of training—half with printed and well illustrated lessons, half with Radio equipment and directions for conducting experiments—gives you broad practical experience while learning—makes learning at home interesting, fascinating, practical.

You must be Satisfied

I make this agreement with you in writing—if you are not entirely satisfied when you finish my Course, with the lesson and instruction service I have given you, every penny you have paid me for tuition will be refunded.

Get my book on Radio's Opportunities. Get a Free Lesson too

Mail coupon now. I'll send you "Rich Rewards in Radio" and a FREE lesson at once. Find out about Radio's spare time and full time opportunities: read what others who have taken my Course are doing and making. Read the lesson, decide for yourself whether my training is clear, interesting, practical. There is no obligation. Act at once. Mail coupon in an envelope or paste on a 1c card. Do it right now.

J. E. SMITH, President
National Radio Institute, Dept. 4K58
Washington, D. C.

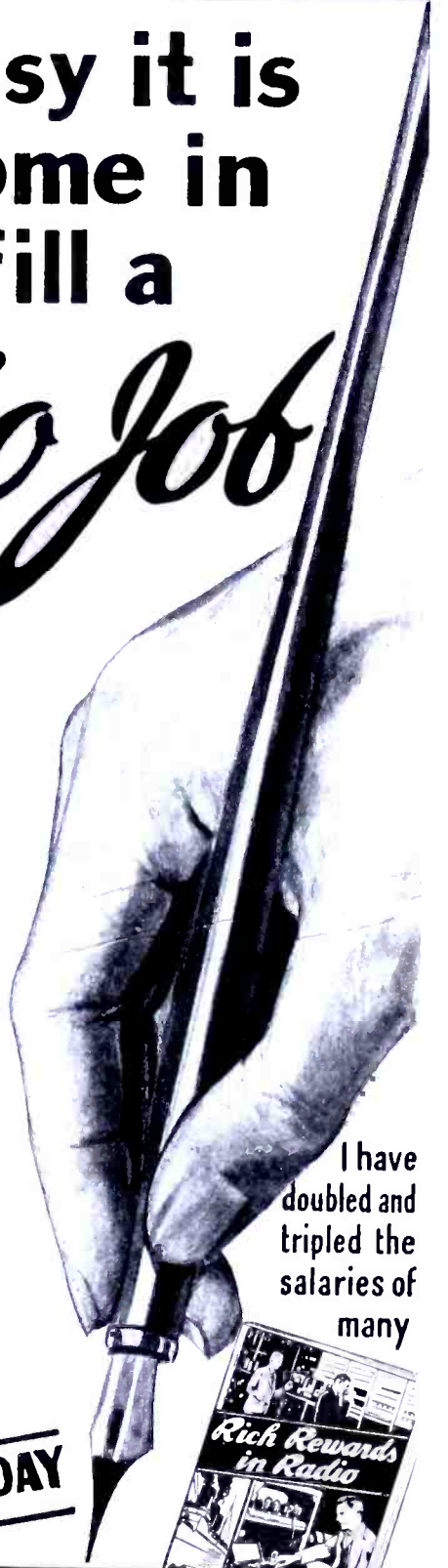

I have doubled and tripled the salaries of many

MAIL THIS TODAY

Good for FREE SAMPLE LESSON and BOOK on RADIO'S OPPORTUNITIES

J. E. SMITH, President
National Radio Institute, Dept. 4K58
Washington, D. C.

I want to take advantage of your offer. Without obligating me, send me your Free Sample Lesson and your book, "Rich Rewards in Radio."
(Please print plainly.)

NAME AGE
ADDRESS
CITY STATE "R"

The Tested Way to BETTER PAY

SHORT WAVE RADIO

devoted to short-wave transmission and reception in all their phases

Robert Hertzberg, *Editor*

Louis Martin, B. S., *Technical Director*

IN THIS ISSUE:

Of General Interest

Sun Spots and Radio Reception.....	4
VK2ME, VK3ME—Voices of Australia.....	6
Division of the Federal Communications Commission	7
Book Review	23
Some Notes on Amateur Licenses	27
Foreign Station Department, by J. B. L. Hinds	28
Addresses of World S.W. Stations.....	31
Revised Police List.....	32
List of International Call Assignments.....	32
Best Short Wave Stations.....	33
Complete Index to Volume I, by Subjects....	35

Of Explanatory Nature

Welcome Receiver Changes by Robert S. Kruse	8
A Discussion of Sensitivity, Selectivity and Fidelity	10
A Technical Discussion of the Stromberg-Carlson 69 S.W. Converter.....	12

For the Constructor:

A New S.W. Converter Using Regeneration by Jay C. Boyd	14
How to Build a $\frac{3}{4}$ -Meter Transmitter by John L. Rennick	17
Building and Operating a Good 2-Tube Preselector, by B. Herbert Russ.....	18
A 100-Watt Phone Transmitter by McMurdo Silver	20
How to Build and Operate a Simple Two-Tuber by S. S. Horwitz	22
The "All Star"—An All-Wave Receiver.....	24
Putting the 12A7 to Work by T. C. Van Alstyne	26

IN FUTURE ISSUES:

WE HAVE A THREE-TUBE SUPERHETERODYNE for your inspection. It's a nice little thing, not too compact, and operated from a separate power pack. It not only "delivers the goods," but is economical as well. We promise this item for an early issue—if it passes tests O.K.

THE FIRST OF THE FALL SUPERHETERODYNES is on its way. This is a commercial receiver with everything including two-stages of r.f. on all bands, a.v.c., band spreading, and maybe hot and cold running water. These supers are getting so monstrous nowadays that a service man will soon be required to have a steam engineer's license to change a tube!

TRANSCIEVERS ARE GAINING in popularity. They have been on the climb for some time now, but this Fall promises to climax the situation. Right now is the time for some of you advanced listeners to start bucking up on the code so you can get a license in time to get on the band wagon. Just in case some of you don't know, a transceiver is a combination transmitter and receiver in one unit. Simple. Economical. Convenient.

The entire contents of SHORT WAVE RADIO are copyrighted by Standard Publications, Inc., and must not be reproduced without permission of the copyright owners.

SHORT WAVE RADIO—Monthly. Entered as second-class matter September 15, 1933, at the post office at Chicago, Illinois, under the Act of March 3, 1879.

SHORT WAVE RADIO is published on the first of every month preceding date of issue. Subscription price is \$2.50 a year in the United States and possessions; Canada and foreign countries \$3.00 a year. Individual copies, \$.25 in the United States and possessions; Canada and foreign countries, \$.30. Published by Standard Publications, Inc., 4600 Diversey Avenue, Chicago, Illinois. Editorial and advertising offices, 192 Lexington Ave., New York, N. Y. Louis Martin, President; Robert Hertzberg, Secretary-Treasurer.

SHORT WAVE RADIO is distributed by Pictorial Distributing Corp., 222 West 39th Street, New York, N. Y.

Articles on short-wave subjects are desired, and are paid for on publication. The editors will be glad to discuss contributions with authors. Unused or unsolicited manuscripts will not be returned unless full postage is furnished by the contributor.

Address all correspondence of editorial or advertising nature to SHORT WAVE RADIO, 192 Lexington Ave., New York, N. Y. Telephone: ASHland 4-5445 and 5446.

McMURDO SILVER  *now presents*
his **MASTERPIECE**

The famous Masterpiece II, choice of Admiral Byrd, has been re-designed into Masterpiece III, and chosen by Paramount Engineers for Use by Bing Crosby and Richard Arlen in the Hollywood International DX Contest.

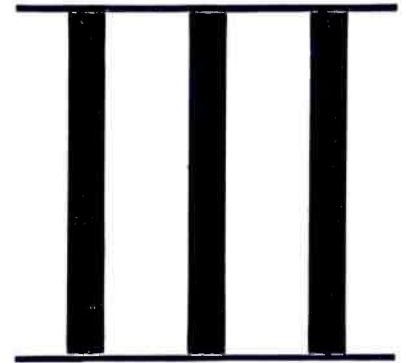
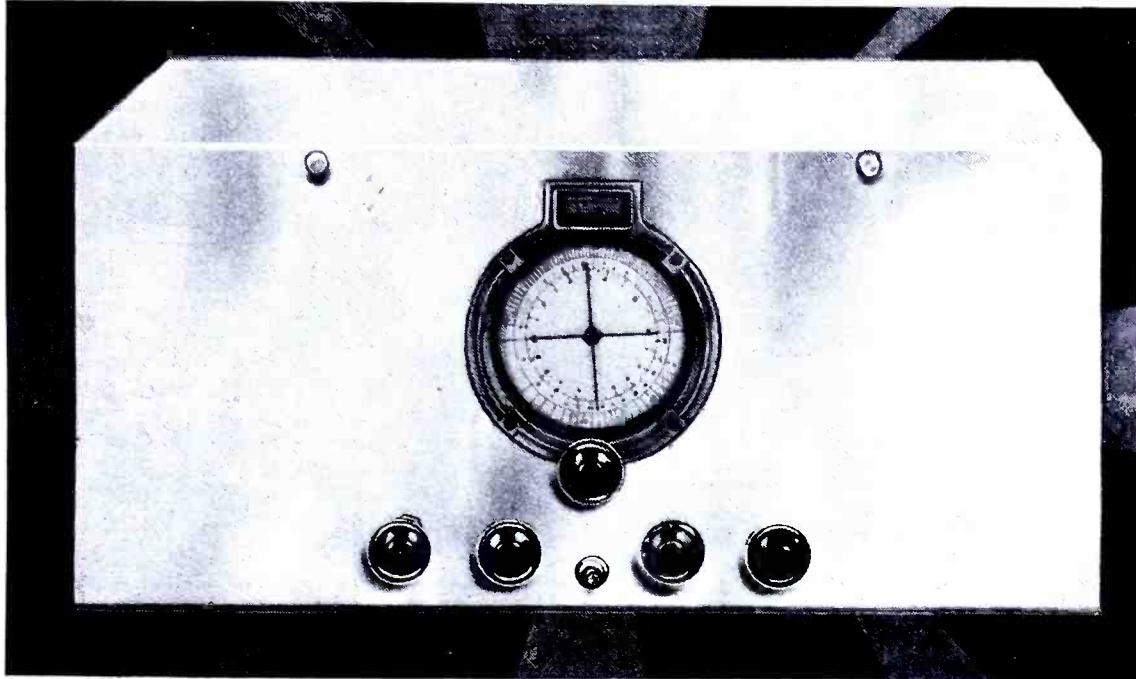

Masterpiece III, by any standard of measurement, by any kind of competitive tests, and in the opinion of everyone who has seen it in action, we believe, is the most complete, the most capable, the most outstanding all-wave radio receiver ever engineered. It will not only out-perform anything else, in laboratory demonstrations, but is positively and unconditionally guaranteed to outperform any other radio receiver in existence . . . right in your own home!

Greatest Foreign Reception Ever Heard

Masterpiece III yields a volume and a quality of tone on transoceanic reception under average conditions, unbelievable excepting to those who have heard it. It brings in with unmistakable identity those small, low-powered foreigners that you have always worked so hard to get, but never did hear.

Band Spread Tuning With New Watch Dial

Simply pull out the tuning knob and the second dial pointer spreads out the crowded short wave band over the full 180 degree scale! Masterpiece III provides actual band-spread tuning over all four wave bands.

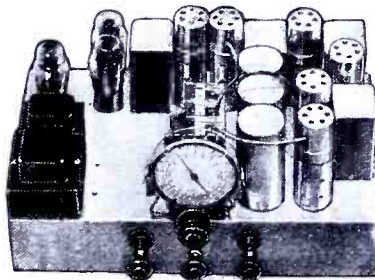
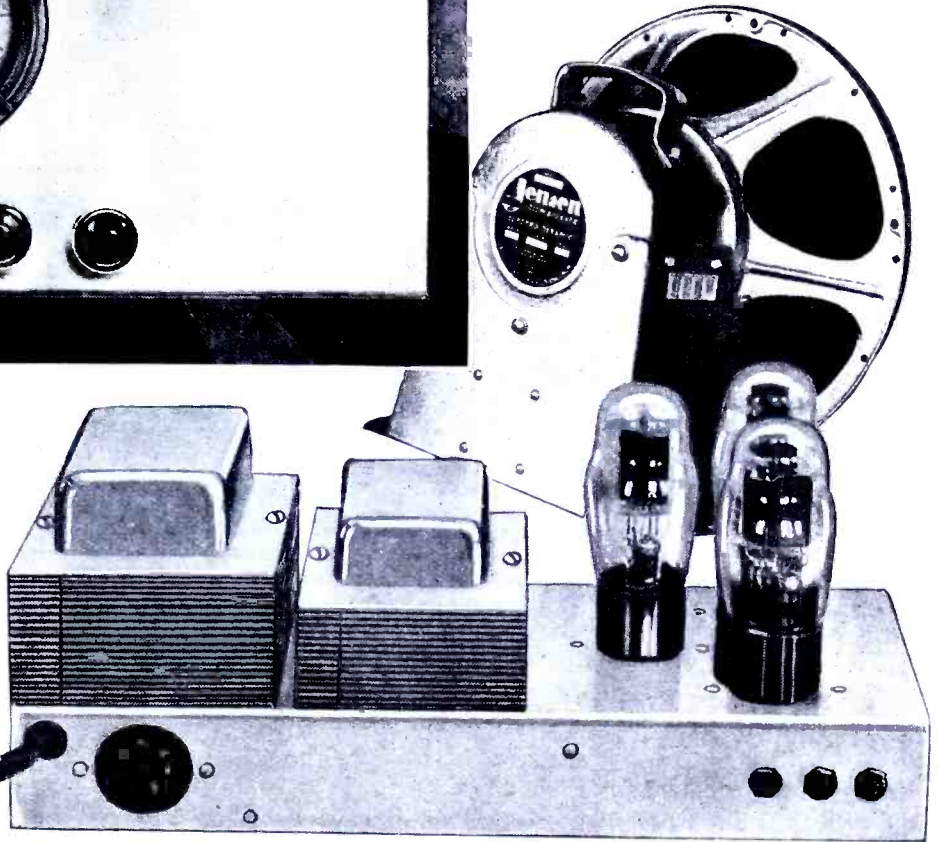

The WORLD-WIDE NINE

Here is a custom-built all-wave receiver that is guaranteed to be the performance-superior of anything in the field excepting only the Masterpiece III—yet it costs no more than the “production” jobs that can't approach it in any way. Actually, the World-Wide Nine is twice as much radio as has ever been given for the money before. Check the coupon and mail it at once for full details.

10 DAY TRIAL

Paramount Engineers heard Masterpiece III, tested it in competition, then selected it for Bing Crosby and Richard Arlen in the Hollywood DX contest. Columbia Broadcasting System heard it, tested it, then installed it as official studio receiver in Chicago. You can put Masterpiece III to the same tests, under your own reception conditions . . . without risking one cent of your money. You can try it 10 full days, then send it back if you want to. It's just as simple as that. Check the coupon and mail it at once, for particulars and full details of Masterpiece III's most amazing specifications.

McMURDO SILVER, INC.
3360 N. Paulina Street Chicago, U. S. A.

McMURDO SILVER, Inc.,
 3360 N. Paulina St., Chicago, U. S. A.
 Send me full particulars and specifications of
 MASTERPIECE III WORLD-WIDE NINE
 Name _____
 Street _____
 Town _____ State _____

Sun Spots and Radio Reception

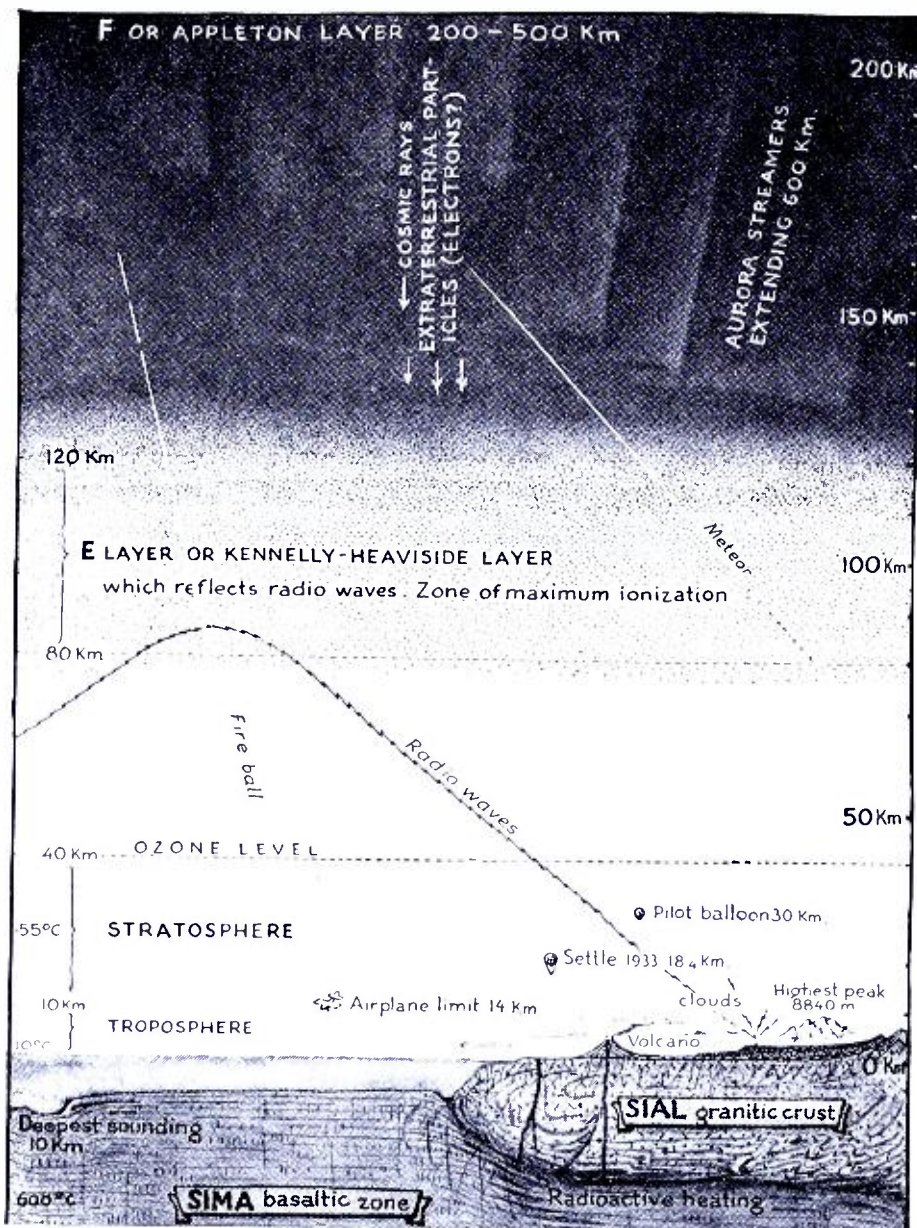

(Illustrations courtesy Whittlesey House)

Cross section of the earth and atmosphere above it. Note the various heights to which the different layers extend: the troposphere, 10 km. above the surface of the earth; the stratosphere, from 10 to 40 km. Note also the position of the E layer discussed.

A GREAT deal of interest on the effect of the new sun-spot cycle on short-wave reception exists at this time. The reason for this sudden spurt of interest is simply the fact that we are now entering, or have just entered, upon a new cycle of spots. That a correlation between radio reception and the number of spots on the sun exists has been substantiated time and time again, although it is only since about 1923 that consistent records of the correlation have been kept.

In a book entitled, *Earth, Radio and the Stars*, by Stetson, some very interesting data have been presented which shows the extent of the correlation of sun-spot activity and radio reception. It is our purpose here to abstract some of the information

that most nearly approaches the needs of short-wave listeners.

Before entering into any detailed discussion of the effect of the sun spots, it might be well to outline, briefly, the general conditions surrounding the sun when the spots are most numerous, then describe just what conditions affect radio reception, and, finally, how the sun spots will influence reception during the next five years or so.

A careful scrutiny of the sun's surface reveals the existence of certain dark spots, which appear and vanish periodically every eleven years. The nature of these so-called sun spots was first established by Hale at the Mt. Wilson Observatory as terrific hurricanes traversing the solar atmosphere accompanied by powerful electric and magnetic dis-

turbances. A study of these disturbances revealed that, in the neighborhood of the spots, the sun's atmosphere was torn by gigantic whirls and spiral vortices similar to the formation of tornados and cyclones in the earth's atmosphere. A further analysis of the nature of the light emitted from the interior of these solar vortices showed that they were the centers of powerful electromagnetic forces.

Just why the eleven-year period exists is still a mystery. Certain astrophysicists have attempted to form a theory based upon the electric and gravitational effects of the planets which circulate about the sun; but it seems more than probable that the behavior of these sun spots is due more to trouble within the sun itself rather than to its planetary environment.

However, regardless of the cause of the spots, it is sufficient for us to know that their existence affects radio reception, and it is our purpose to outline just how we are affected.

What Sun Spots Are

Those of us who have followed the formation of sun spots know that in 1928-1929 the surface of the sun was continuously disturbed by violent outbreaks of sun spots, and we were, then, in the midst of a sun-spot maximum—the sun had the greatest number of spots on its surface. During 1933-1934 the surface of the sun had a minimum number of spots, and we were, of course, in a sun spot minimum. If the sun continues this cyclic phenomenon, we may expect another sun-spot maximum during 1939-1940.

That the eleven year period will continue may be predicted from the fact that maxima have taken place during 1837, 1848, 1859, 1870, 1883, 1893, 1905, 1917 and 1928. And the fact that we are now rising toward a maximum again, substantiates the statement.

The transmission of radio signals involves the problems of electromagnetism, and since radio signals are affected by changes in the condition of the sun, it is natural that one look to the upper atmosphere of the earth for direct changes which, in turn, affect radio signals. It is also probable that the higher altitudes are more easily influenced by solar radiation.

For the most part, the bulk of the air by weight is contained in the lower atmosphere, near the surface of the earth, which region is known as the *troposphere*, and extends to about 10 or 12 kilometers above the earth's surface. The temperature throughout the troposphere falls uniformly up to about 12 km above the earth where it remains fairly constant at about 55° C below zero.

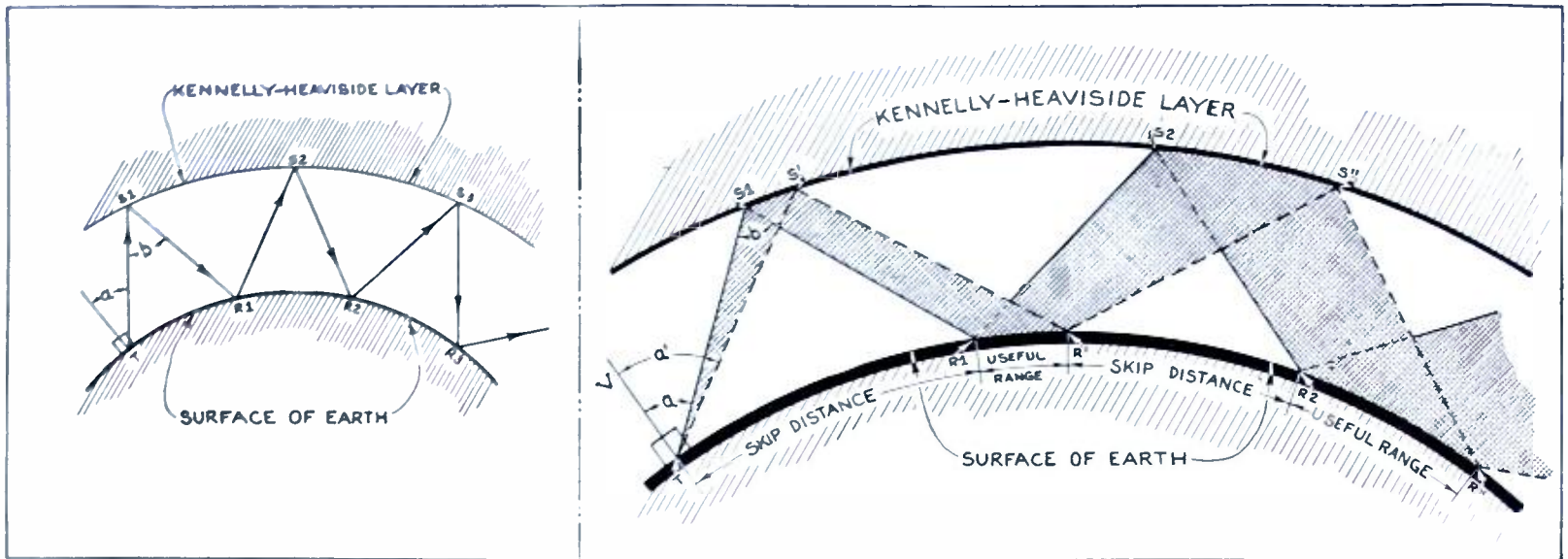

Fig. 1: Left, simple reflection showing points of reception; right, complex reception showing zones of reception.

Also, of course, as the distance above the earth increases, the atmospheric pressure decreases, until at about 50 km, the pressure is about one-fifteen hundredth of that at the earth's surface. This region, from about 10 to 50 km above the earth, is known as the *stratosphere*.

These high layers appear to be electrically conductive, owing to the fact that the molecules of the gas have become ionized due to the absorption of solar energy. Ionization is further enhanced by the fact that the distance between molecules is large due to the low pressure (long mean free path), so that a molecule or electron may obtain considerable momentum before colliding with another molecule and knocking an electron from it.

Importance of Ions

The problem of ionization of the upper atmosphere is of fundamental importance as far as radio transmission is concerned—especially short-wave transmission—so that it is well to consider further the possible causes of ionization. Although radioactivity in the crust of the earth is responsible for ionization near the surface of the earth, it is reasonable to suppose that ionization from this source decreases rapidly with increasing distance, and we must look to outside sources such as the sun, the stars, and interstellar cosmic radiation for producing ionization in the stratosphere.

Starlight radiations are relatively small, the best indications being that it is not more than one-thousandth of that of the sun, and for our purpose, may be disregarded. Cosmic radiations have been investigated by Compton, Millikan and others; but the constancy of ionization from this source gives little basis for assuming that it is an important factor as far as any *periodic* changes of the degree of ionization are concerned. It seems probable, therefore, that the sun is the principle ionizing agent with which we have to contend.

It is believed that in addition to the powerful ionizing agent found in

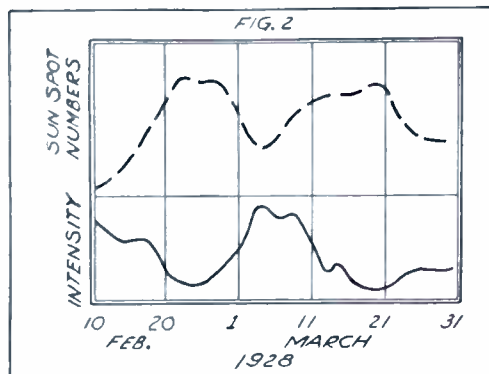

Radio reception and number of sun spots during the months of February and March. Dotted curve represents sun spots.

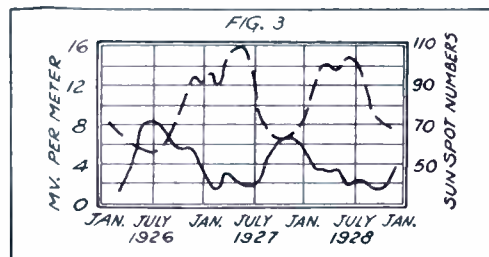

An interesting correlation is pictured here for 1926, 1927 and 1928. Dotted curve represents number of sun spots.

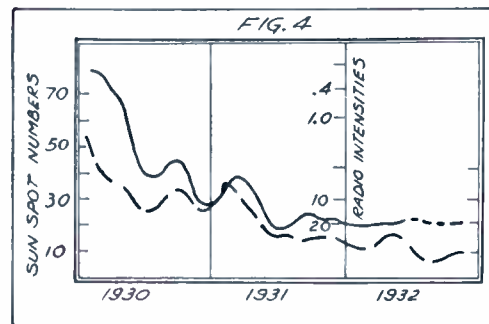

Another correlation. Only a specified section of the sun-spot area was considered.

the ultra-violet radiation from the sun, electrons, ions and alpha particles expelled from the sun's interior are responsible for ionizing the upper part of the solar atmosphere; and that the highly ionized layers surrounding the sun (the *chromospheres*) are responsible for exciting the powerful radiation in the extreme ultra-violet of the spectrum to an extent far greater than could be expected from the sun's temperature—some 6000 ° C.

The fact that some basis for supporting this claim exists may be

gleaned when it is considered that the electrical conductivity of the atmosphere appears about 50% greater during sun-spot maxima than at sun-spot minima. It appears, then, that the sun spots are in some way responsible for increasing the ionization state of the terrestrial atmosphere.

It was in 1902 that Kennelly, in America, and Heaviside, in England, came to the conclusion that radio waves encountered a conducting layer in the upper regions of the earth's atmosphere and were *reflected* from this surface back to the earth. This layer, commonly known as the Kennelly-Heaviside layer, or the *ionosphere*, has played a very conspicuous part in the science of radio.

The E and F Layers

Investigations both in this country and abroad have shown the possible existence of at least two distinct layers instead of one, known as the *E* and *F* layers, from which radio waves are turned back to earth. Just which layer does the turning back depends, among other things, upon the frequency of the radio signal. For frequencies up to 3000 kc. (100 meters) reflection takes place at an average altitude of about 100 km during daylight hours; frequencies in the neighborhood of 5000 kc. (60 meters) show a similar response from a layer 200 to 300 km in height. Ordinary broadcast waves are returned to earth from the *E* layer.

Opinion differs as to the exact mechanism involved in the return of radio waves: some prefer to think of it as direct reflection, such as light from a mirror, while others consider the phenomenon to be one of refraction. In all probability a combination of the two takes place, the predominating one depending upon the degree of ionization and the frequency of the signal.

The diagram of Fig. 1 (reproduced from our November, 1933, issue) shows how refraction, or reflection, takes place. The diagram (Continued on page 38)

VK2ME, VK3ME— Voices of Australia

SUMMARY: *Situated in beautiful Australia, the two sister stations, VK2ME and VK3ME, are known throughout the world for their excellent transmissions. It is with pleasure that we are able to present this brief description of these stations, prepared especially for us by the directors of the stations. For further information, write the stations.*

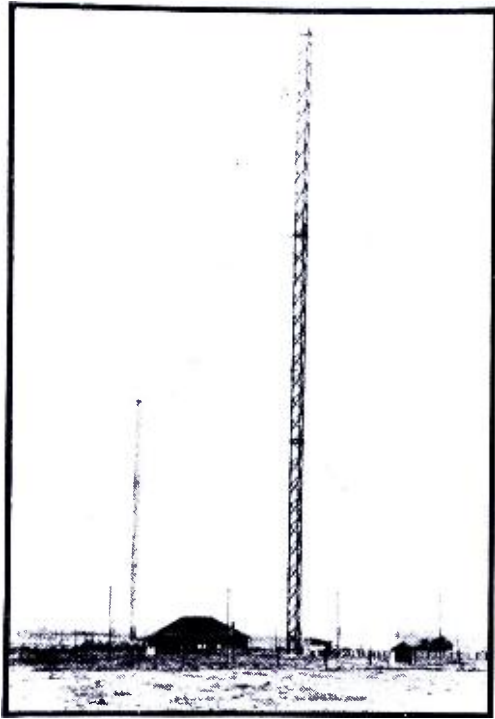

Aerials of the short-wave station VK3ME, situated at Radio Centre, Victoria.

THE short-wave world-wide broadcasting service of Amalgamated Wireless is effected from station VK2ME, which is located at the A.W.A. Radio Centre, Pennant Hills, 14 miles from Sydney. At the Sydney Radio Centre, comprising an area of 40 acres, more radio transmitters are located under one roof than at any other place in the Southern Hemisphere. Here, fifteen transmitters are situated, some of them working almost constantly.

The main mast is 400 feet in height and many aerials are suspended from it to smaller masts, each aerial system providing a different service.

VK2ME

The studio of VK2ME is at the headquarters of Amalgamated Wireless, in York Street, Sydney, Australia, and from here all programs are transmitted via landlines to Pennant Hills. The largest transmitter at Radio Centre is used for the world broadcasts. VK2ME is known as "The Voice of Australia," and is a 20 kilowatt instrument. Actually, over 60 k.w. is required to operate this transmitter. Twenty-two large oil and air-cooled tubes are used, mounted in seven separate units.

On July 5th, 1931, A.W.A. inaugurated the first regular world-wide broadcasting service arranged in an entirely new way, inasmuch as different sections of the world were served by a program at a time most suitable for reception and relay in the respective countries. To accomplish this the transmissions are divided into four periods: the first session covers the western portion of North and South America; the second embraces the southern and eastern portions of Australia, New Zealand, Papua, New Guinea, Fiji,

New Caledonia, the New Hebrides and other islands; the third covers Western Australia, China, Japan, Philippine Islands, the Straits Settlements and most of India; and the fourth serves Great Britain, Western Europe, South Africa, Rhodesia and Egypt.

VK2ME is on the air every weekend and uses a wavelength of 31.28 meters (9.59 megacycles) which has proved suitable for long distance work.

It is well-known to radio engineers that at various times of the day radio stations are heard at particular places better than at other times. After about two years of experimenting, the Company's engineers worked out the time of the day or night at which VK2ME is best received in various countries. In the light of this information, programs are radiated at the times published elsewhere in this issue.

The program of VK2ME comprises both classical and popular musical items, but jazz music is omitted. A few waltz compositions are broadcast and usefulness is added to the program by talks on many phases of Australian life. The Australian National Travel Association prepares many of these talks, and there is abundance of evidence that residents of many parts of the world have been favorably impressed with Australia as a place to be visited when opportunity affords.

Many overseas records have been effected through VK2ME, Sydney. To Australia fell the honor of transmitting the first Empire broadcast program on September 5th, 1927. The reception in Great Britain was

remarkably successful, and the program was rebroadcast by the British Broadcasting Corporation to listeners throughout Great Britain. It is estimated that over one million listeners heard the program.

This was followed, on October 17th, 1927, by transmitting the second, and what might be termed the first world-wide, program through station VK2ME. This was the first occasion in Australia on which programs were transmitted on dual wavelengths—the normal wavelength of station 2FC, 422 meters for local reception and that of the special experimental station VK2ME (at that time 28.5 meters) for overseas reception and rebroadcasting by the British Broadcasting Corporation.

The world-wide interest occasioned by the Eucharistic Congress in Sydney was increased by A.W.A. transmitting the proceedings to England and America through Station VK2ME, and the successful rebroadcasting in the latter country.

Another notable transmission was effected on January 10th, 1930, when the singing and talking portions of the Paramount "talkie" film, "The Love Parade," starring Maurice Chevalier, were transmitted from the Prince Edward Theater, Sydney, to Commander Byrd at the South Pole. The transmission was effected on the 20 kw. overseas transmitter designed and manufactured in Australia by A.W.A.

About half an hour after the transmission, Commander Byrd signalled back via San Francisco and A.W.A. Radio Centre, Pennant Hills:



Transmitter room at A. W. A. Radio Centre, Braybrook, Victoria, where the transmitter of the short-wave station VK3ME is situated. This is the smaller of the two stations.

"2ME Sydney. As Paramount's most southern representatives at Antarctica, we are pleased to report your fine broadcast of the Paramount Sound Picture, 'The Love Parade,' enjoyed and greatly appreciated. This is the first sound reproduction received here. Admiral Byrd and inhabitants of the Antarctica join us in thanking you for your program and best wishes—Joseph Rocker and Willard Van de Veer, Paramount's Cameramen in Byrd's Antarctic Expedition."

Station VK3ME

VK3ME, the Melbourne short-wave experimental station of Amalgamated Wireless Ltd., has been in operation with regular programs for two years, and during that time its transmissions have been intercepted in all parts of the world.

The station operates on a frequency of 9,510 kc. (31.54 meters) and conducts a schedule made up principally of recorded music, each Wednesday from 7 A.M. to 8:30 A.M., Eastern Standard time, and each Saturday from 7 A.M. to 9 P.M. E.S.T.

In spite of the fact that the aerial power of the station is less than 2 kilowatts, VK3ME puts down a considerable field strength, not only in Australia, but in many overseas countries, particularly in the United States of America.

A very beautiful airplane view of the A. W. A. Radio Centre, Penant Hills, where the short-wave station VK2ME is located, showing the 400-foot mast. It is no wonder that this station is so strong in America, considering the almost ideal location.

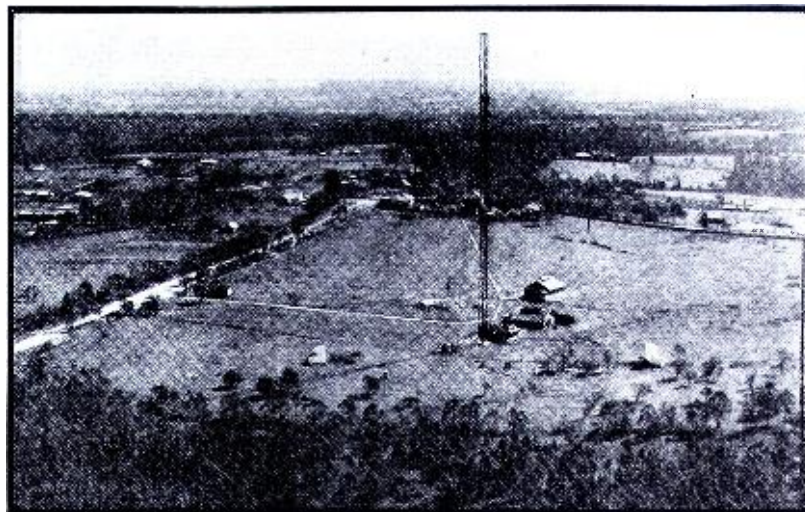

Prior to the commencement of a regular scheme of transmission, the station was used extensively for long-distance experimental work, and, in collaboration with the General Electric Company of America, much valuable data was secured. A notable example of two-way working in which VK3ME and W2XAF, Schenectady, took part, was the occasion on which the Rotary Club of Melbourne and the Rotary Club of Schenectady conducted a joint meeting some 18 months ago. Loudspeakers in the respective club-rooms rendered the distant proceedings audible, and the signal from each end was of such strength and clarity as to render the experiment a complete success.

Since the regular service was inaugurated, some thousand or so letters have been received from listeners outside Australia, and many notable reception feats have been recorded; the chief of which was that of Mr. E. H. Scott of 4450 Ravenswood Avenue, Chicago, Ill., who, during twelve months, missed only three of our regular schedules.

The aerial which is of the half-wave type, is situated at a distance from the transmitter and is energized by means of a two-wire radio frequency feeder line.

VK3ME is located at the Amalgamated Wireless Victorian Transmitting Centre at Braybrook, about six miles west of Melbourne. See the photographs for additional data.

Divisions of the Federal Communications Commission

THE Federal Communications Commission organized its division on July 17, 1934, in keeping with the Communications Act. Three divisions composed of three members each were created, with Chairman E. O. Sykes serving on each division. The divisions and personnel follow:

DIVISION NO. 1.—BROADCASTING
Commissioner Gary, Chairman
Commissioner Brown, Vice Chairman
Commissioner Sykes.

DIVISION NO. 2.—TELEGRAPH
Commissioner Stewart, Chairman
Commissioner Payne, Vice Chairman
Commissioner Sykes.

DIVISION NO. 3.—TELEPHONE
Commissioner Walker—Chairman
Commissioner Case—Vice-Chairman
Commissioner Sykes.

The Broadcast Division shall have and exercise jurisdiction over all matters relating to or connected with broadcasting.

The Telegraph Division shall have and exercise jurisdiction over all matters relating to, or connected with record communications by wire, radio or cable, and all forms and classes of fixed and mobile

radio-telegraph services and amateur services.

The Telephone Division shall have and exercise jurisdiction over all matters relating to, or connected with telephone communication (other than broadcasting) by wire, radio or cable, including all forms of fixed and mobile radiotelephone service except as otherwise herein specifically provided for.

The whole Commission shall have and exercise jurisdiction over all matters not herein otherwise specifically allocated to a division; over all matters which fall within the jurisdiction of two or more of the divisions established by this order; and over the assignment of bands of frequencies to the various radio services. In any case where a conflict arises as to the jurisdiction of any division or where jurisdiction of any matter or service is not allocated to a division, the Commission shall determine whether the whole Commission or a division thereof shall have and exercise jurisdiction, and if a division, the one which shall have and exercise such jurisdiction.

The following radio services and classes of stations were allocated to the three divisions established as follows:

I. TO THE BROADCAST DIVISION Service

Broadcast
Temporary
Experimental
Class of Station
Broadcast Pickup
Experimental Visual Broadcast
Experimental Relay Broadcast
Experimental Broadcast
General Experimental (1)
Special Experimental (1).

(1) All matters relating to or connected with this class of station concerning the development of apparatus for any service assigned to the Broadcast Division.

II. TO THE TELEGRAPH DIVISION Service

Aviation
Aviation Public
Public Coastal
Private Coastal
Experimental
Geophysical
Fixed Public
Fixed Private
Emergency
Agriculture
Marine Relay.
Mobile Press
Fixed Public Press
Amateur
Temporary
Ship

Class of Station
Aeronautical
(Continued on page 42)

Welcome Receiver Changes

By Robert S. Kruse*

Illustrations by the Author



SUMMARY: Look out! here comes Kruse with some simple, and certainly timely suggestions, so watch yourself, you art directors. This man Kruse knows his oats; he's been through the mill, and when he speaks, he unburdens himself plenty. This time he wants dials that not only work, but are readable; he wants scales that don't require rubber pointers; he wants smooth working dials that can be turned without the aid of a crowbar; he wants standard sized machine screws; he wants chassis that are not skimpy; he wants to make service men chairmen of boards; he wants—but you had better hear all this from Kruse.

decent enough fellow, though mildly insane. This is the standard belief of sales and engineering departments. That subject is now used up.

Arty

No engineer, I think, has ever been quite reconciled to the art department's fixed idea that the dial is a thing which must be made to look like something else. Give the average art department a plain round celluloid scale with plain markings and a straight black pointer, and instructions to design an escutcheon to go around the dial. Now wait four days. A folder is sent down containing five proposed designs. None of them have plain pointers. One has a round scale but it is filled up with scroll-work. The other four show scales that are square, oval, octagonal and accidental. Since the pointer isn't made of rubber it is too short in some places and too long in others. An inter-departmental conference results. Many unkind things are said all around. This conference costs the company approximately \$435.60. The dial that finally emerges is bought ready-made from a firm in another city at 23c each.

Readability

While on the subject of dials, one is pleased to notice that readability is beginning to gain ground at last, perhaps for the very reason that more dials are coming from professional dial makers. Perhaps a better guess is that the close adjustments needed for the cramped short-wave tuning of combination standard and short-wave receivers have caused better scales to look worth-while to manufacturers.

At any rate we are, this year, seeing some readable dials. They are not plain enough yet, the figures tend to be too small, the pointers too far from the scale, and there are too many markings, but we are getting on. Perhaps we shall some day approach the plain simplicity of a tower-clock dial which needs only 12 marks (not numbers) to permit positive readings to 1/288 of a day, and

quick estimating to 1/1440 of a day. The words "not numbers" above, refer to the fairly well-known fact that on a familiar scale a black "blob" is as good as a readable number.

One of the sketches with this story shows a dial which was put on a tower-clock in a large American city, replacing a numbered dial. Six months later an "enquiring reporter" asked 50 people if they had seen anything unusual about the clock-face. Forty-four of them had never observed that it had no numbers, although forty-six of the fifty set their watches by it. The point is that after a few weeks use of a radio receiver one goes largely by the "position appearance" of the pointer, using the scale less and less. If the pointer is bold and straight, this permits one to make a setting easily and with a prompt approximation of the desired final setting. If the pointer is "arty," or the scale of odd shape, this facility is limited or non-existent.

Plain figures of fair size facilitate the original familiarization, then gradually become less important.

Mechanics

To many of us certain receivers are unpleasant because the control knob is mulish in action, offering excessive resistance to turning. One of the sketches herewith shows a very simple way of testing dial-resistance with materials found on any office desk. An ordinary sheet of Hammarmill or similar typewriter paper is folded up into a strip slightly less than an inch wide, and having a length equal to the original width of the sheet—to wit, 8½". This strip is fastened temporarily to the tuning-control knob with a rubber band as sketched. With a paper clip and a 25c piece one now weights one end of the lever, moving the "two bits" out until its weight turns the knob. On a good modern dial the quarter does not need to go more than four inches out. A General Electric K-80 dial operated at 3¼", an old-old Zenith "string drive" operated at 3 inches, one model of an

ANYONE can find fault. In a controversy both sides always prove the other wrong. Therefore, let us not descend to fault-finding.

Every radio manufacturer would like to lead on—but not too far ahead. There is much room out in front, but the parade may not follow. Too often the result is summed up in Alexander Winton's "It never pays to pioneer." Our back trail is bordered with costly junk—terribly costly. Even where it is the ancestor of something which became commercially successful, the pioneer seldom collected a fair share of the profits.

Therefore, put back that axe and stop eyeing the shotgun. Violence will not help this industry—it has already suffered too much of that from the politicians, and is scared partly loose from its wits. Let's try a bit of moderation and talk about things that are funny instead of those that are (so you think) damnable.

Salesmen and Engineers

To the engineering mind the funniest thing in radio is, of course, always in some other department. We wonder why the sales folks don't try to explain the advantages of a receiver instead of feverishly explaining some trick phrase that has no definite meaning. The sales folk retort with passion that they have put the engineer's jargon into plain English. The engineer then smiles in a manner reminiscent of a nice old aunt who does not especially care to listen to Freddy. Each then tells the other where his salary comes from and both conclude that the other is a

* Consulting Engineer—Technical Editor "R/9".

Atwater-Kent worked at 3¾". On the other hand, the general run of today's dials feel as if they were meant to be run with a Stillson wrench. The "two bit test" would need a lever 3 feet long to make them go. Some of the worst dials yet met have been on alleged short-wave receivers—not combinations. One of them had a mechanically elaborate dial which required \$2.50 hung on the lever at 6 inches to make the knob turn.

Ease of turning is, of course, most appreciated when it is combined with smoothness. Smoothness is not easily measured with simple gadgets like the above, but anyone can feel it. The muscles and nerves of the fingers are very sensitive to such things. A mechanic can slide a ring-gauge along a rod and easily "feel" differences of 1/10,000 of an inch. If the dial mechanism operates smoothly and easily we can get on with a relatively low reduction ratio, and the need for "band spreading" is largely wiped out.

Healthy Derision

The metal pan which we call the chassis is not very costly, nor does its price rise very astonishingly if it is made two inches longer. On the other hand, if we leave the thing too short, there is the deuce to pay when a repair is to be made. Either the repairman must charge for the time spent in playing jackstraws with a tangle of resistors and condenser-cartridges, or else the poor lad takes (another) licking on his small profit

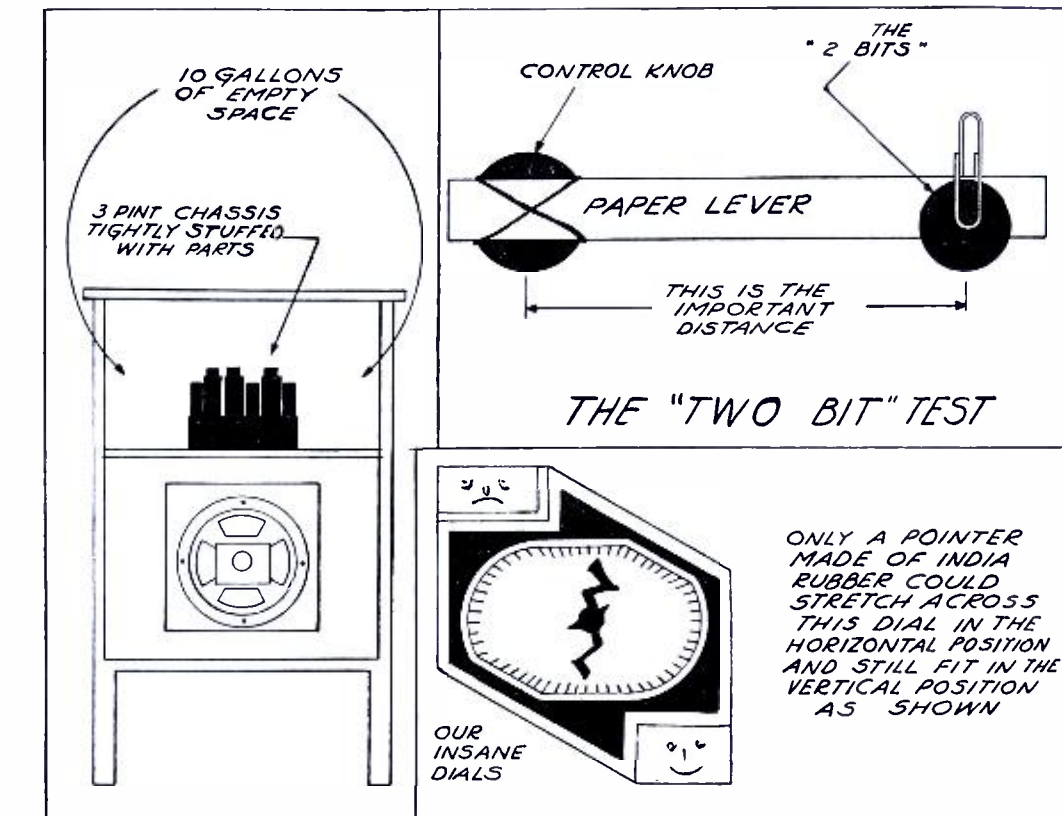

on the job. The large mail-order houses, to whom radio is something of a small item, have learned to avoid this sort of thing by making their sets accessible, and making necessary savings in other ways than clipping 3/8" from a bit of sheet steel.

It is a pretty healthy sign to find that the super-compact receiver is being joshed these days.

The Poor Serviceman

A very good automobile repairman

told me he'd like to see a repairman on the board of every automobile factory; that nothing would save us John Citizens more money.

It is a good idea for radio factories, too. Maybe the repairman ought to be the chairman of the board. If he were a good repairman he would have a fine sixth sense about things-that-look-good-but-will-fall-off. He would put his foot down most ungently on things that are buried under something else. He would know that the repairman does not have flexible soldering coppers or rubber screwdrivers, and that the poor sucker is working against time and does not need to be pestered to make his work hard enough.

Very probably this man would be heartily hated by the engineering department, which always has to untangle everyone's mistakes anyway. He would be simply loathed by the art department because he would object firmly to things-that-will-get-knocked-off. He would be loathed also by the salespeople because he would insist on a set of instructions which instructed, and was etched on a metal sheet and tacked inside each set to make sure that nothing went gee-winkus about the set before the service-slave could get the instructions. Various and assorted people around the plant would hate him for insisting that the model number be marked plainly in some easily visible part of the chassis, that standard screws be used all the way through, that every control have a plain 1/4" shaft, that the dial drive be designed by someone other than Rube Goldberg, and that every small part be plainly marked as to its nature and constants.

He would probably be found dead some morning after recalling the latest flock of advertising material, and would be buried in a lonely place unknown even to the servicemen and the set owners he worked for.

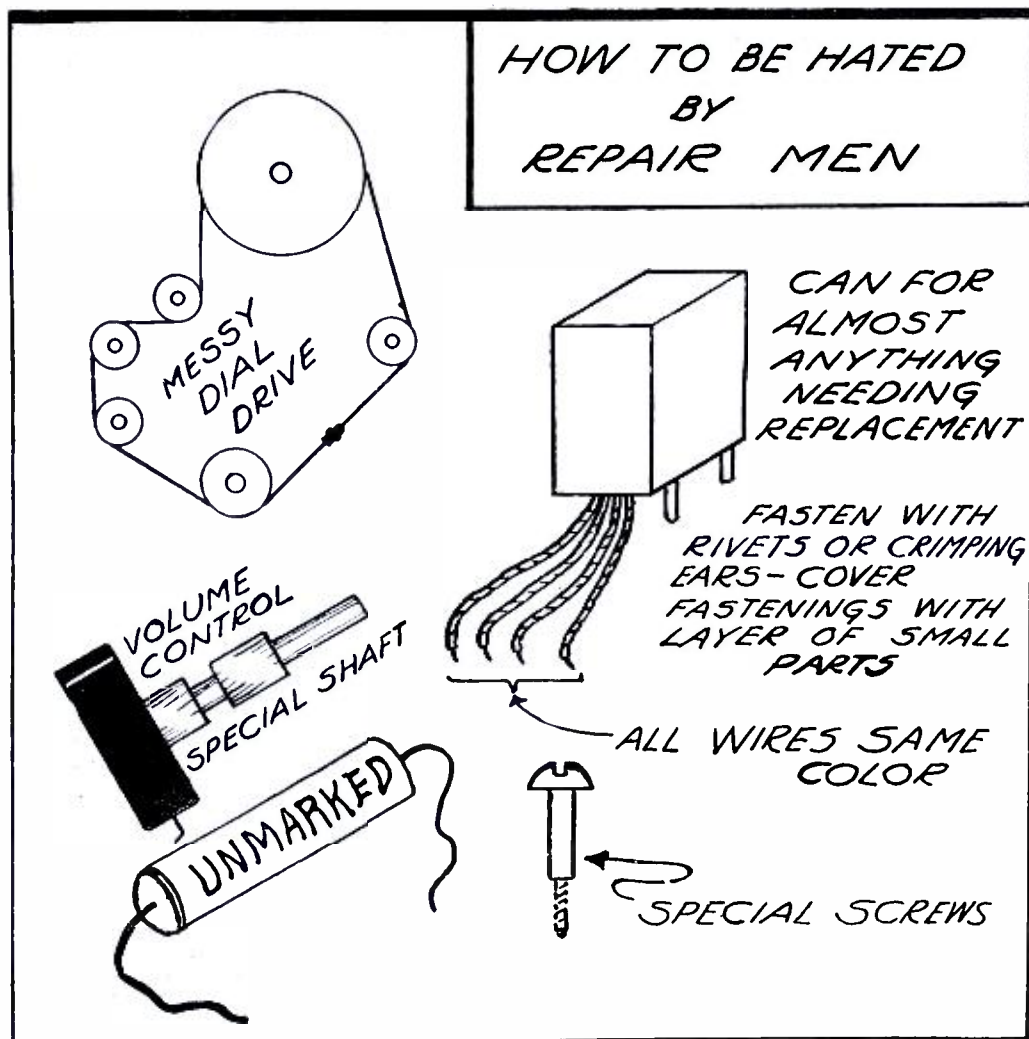

A Discussion of Sensitivity, Selectivity and Fidelity

SUMMARY: A discussion of selectivity, sensitivity and fidelity is given in order that the relations existing between these characteristics of radio receivers be understood by the not-to-technical reader. High gain and selectivity are shown to be functions of the L/C ratio.

DURING the year that this magazine has been in existence we have received hundreds of letters from readers who want the schematic circuit and all technical data for the most sensitive, the most selective, and the most powerful (with *no* distortion!) short- or all-wave receiver capable of being constructed. A very large order, to say the least! It is an order without qualifications of any sort; and our opinion is that it originates from befuddled readers in a spirit of reckless abandon.

The most sensitive receiver is not always the most selective; the most selective receiver is not always the most sensitive; and the most powerful (a horrible technical word) receiver may be neither selective nor sensitive and may have severe distortion.

Sensitivity, selectivity and fidelity (the last term will be defined shortly) are properties of receivers which must be considered with respect to the particular location of the receiver, and those now available are compromises. To be sure, many of the compromises are good ones and adequately serve the great majority of users. However, to fully appreciate what each term means and what relation each term bears to the others, it is necessary to know their characteristics.

Selectivity

Selectivity is defined as that property of a radio receiver which enables it to discriminate between radio signals of different carrier frequencies. This property rests almost entirely in the tuned circuits, whether they be in the r.f. detector, or the i.f. stages of a superheterodyne. A receiver is said to be *sharp* when it can easily discriminate between two stations which lie close together; and is said to be *broad* when it cannot so discriminate.

The idea that discrimination is a virtue may not be at all valid when it comes to radio receivers. The amount of desirable discrimination depends upon frequency of operation and the condition of the air. For instance, in the broadcast band extending from, say, 1500 to 500 kc., there is a 1000 kc. span for all the stations in the country. Now, since each station is arbitrarily allotted 5 kc. on either side of the carrier, the sta-

tions within a given area cannot be less than 10 kc. apart if interference is to be eliminated at all. This restriction immediately makes any radio set that can separate stations 10 kc. apart selective.

From these remarks one can see that 10 kc. selectivity is a good thing on the broadcast band, but how good is it on 49 meters, where a great many countries of the world are jammed close together? With such an unorganized condition, it may be necessary to have 5 kc. selectivity (2500 cycles being the highest audio note received with any degree of volume) in order to prevent interference.

The curve of Fig. 1 is the selectivity curve of a typical superheterodyne receiver used for broadcast purposes. The curve was taken by tuning the receiver to 1400 kc. and applying a signal of varying frequency—varying from 20 kc. below to 20 kc. above resonance. At 5 kc. off resonance, the response of the tuned circuits is but .1 of that at resonance, corresponding to a 20 db decrease. And yet this receiver is considered fairly good—good for the simple and obvious reason that 10 kc. off resonance, where the adjacent channel lies, the response of the receiver is 1/400 of that at resonance.

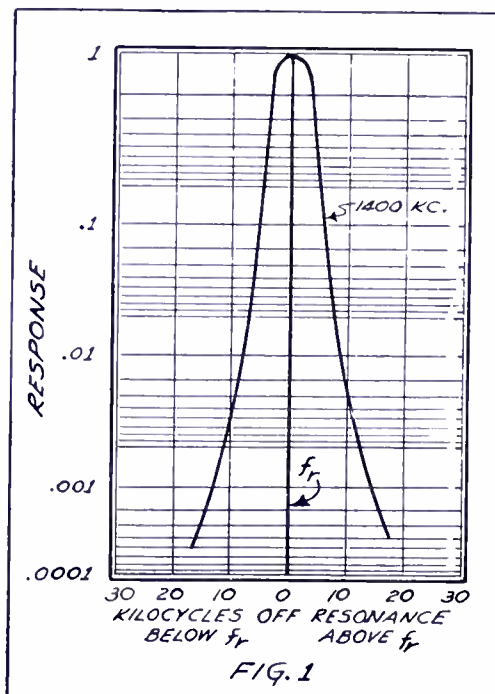

FIG. 1
Selectivity curve of a typical radio receiver of a few years ago. Note the response 5 kilocycles off resonance.

The selectivity of a receiver depends upon the resistance of the coils used in the tuned circuits. The current flowing in any tuned circuit is very nearly equal to the induced voltage divided by the resistance of the coil, at resonance. The lower the resistance or the greater the induced voltage, the greater the circulating current, which means a high voltage applied to the grid of the tube.

But we have a choice of using a large inductance with a small condenser or a small inductance and a large condenser, so long as the combination is correct for the resonant frequency desired. Which is the best, and why? The curves of Fig. 2 tell the story—as far as selectivity is concerned. Curve 1 is for a small inductance and large capacitance; curve 2 is for a larger inductance and smaller capacitance; curve 3 is for a still larger inductance and correspondingly smaller condenser; curve 4 represents the conditions when using a very large inductance and a very small capacitance. It should be mentioned that the resistance of the circuit and the induced voltage were adjusted to remain the same for all the curves. Note how broad curve 1 is and how slender curve 4 is, although the resonant frequency of both combinations is the same. The selectivity of circuit 4 is far greater than of circuit 1.

Reason for Shape

The reason for the changing shape becomes apparent when it is realized that the reactance of a coil increases and that of a condenser decreases with increasing frequency. Thus, when a resistance, and inductance and a capacitance are connected in series and adjusted to resonance with an applied signal, a certain current flows. If the applied signal is increased in frequency, less current must flow because the inductive reactance has increased more than the capacitive reactance has decreased, resulting in a net increase in reactance?

This condition is shown by the curves of Fig. 3. The upper solid line is the inductive reactance and the lower solid line is the capacitive reactance. At the point where both are equal there is resonance. Suppose the applied frequency is raised, as shown. The inductive reactance increase is greater than the capacitive decrease, and the current in the tuned circuit goes down.

Suppose, now, that we double the inductance and halve the capacitance; the resonant frequency will remain the same. The new inductive reactance is shown by the upper dotted line and the new capacitive reactance by the lower dotted line. At the same increased frequency as used before, the new net increase in reactance is *greater* than before, so that for the new LC combination, the current off resonance is less than ever.

All this explanation shows that with constant resistance in the circuit the selectivity curve of the tuned circuits in the receiver may be made sharper by using as high a value of inductance as possible.

The selectivity of a receiver is really the selectivity of the tuned circuits of the receiver, and, with a given amount of coupling between coils, may be increased by keeping the resistance low and the inductance high. When a given band is to be covered with a given size condenser, however, there is but one size coil that can fit the bill, and to gain selectivity there are but two choices: either increase the number of tuned stages or decrease the resistance of each tuned circuit. The latter is more or less fixed by the physical size and shape of the coil, so that it is sometimes more expedient to use more tuned stages—an important advantage of the superheterodyne.

Figure 4 shows how the selectivity of a receiver varies as the number of tuned circuits increases—i.f. stages of superheterodynes may be included in this analysis. The important thing to note is that the total selectivity curve is equal to the product of the individual selectivity curves—not the sum, as stated by one of our contemporaries. Note also that the curve for three stages is very narrow at the bottom, resulting in a minimum of signal strength, which may also mean a minimum of noise.

Sensitivity

Sensitivity may be defined as the ability of a receiver to respond to small radio-signal voltages—any receiver that can respond to a very small signal is sensitive.

Now, this term, unless properly interpreted, can leave a lot of wrong impressions. A poorly designed receiver with a multiplicity of tubes can bring in as many stations as a well-designed set with fewer tubes. This does not mean that a receiver with a lot of tubes is necessarily poor. On the contrary, many of the multi-tube sets now on the market use separate tubes for each function, which raises the grand total although comparatively few contribute to actual signal amplification.

Sensitivity is measured in the laboratory by determining the actual input voltage required to maintain the output constant at 50 milliwatts. This mode of measurement does not take into consideration separate a.v.c. and q.a.v.c. tubes, oscillator tube, beat oscillator tube, etc.; it merely considered the sensitivity regardless of what amplifies the signal. In general, it may be stated that the sensitivity of a set rises with the efficiency of the tuned circuits, assuming a constant number of tubes and proper impedances in the circuits.

Fidelity

Fidelity is the accuracy with which a radio receiver reproduces

the intelligence contained in the modulated wave of the signal picked up by the antenna. As ordinarily used, it applies only to frequency distortion, although amplitude and phase distortion should be included in a strictly technical discussion. We will confine our attention to its use as measure of the frequency distortion. In case some of us have forgotten, frequency distortion is the distortion due to the amplification of some frequencies more than others.

A fairly good broadcast station will radiate a wave having good signal strength 5000 cycles either side of the carrier—will radiate a 5000 cycle audio note with ease. A good receiver should be able to receive this 5000 cycle note with at least the same ease, else there is no use radiating it in the first place. This

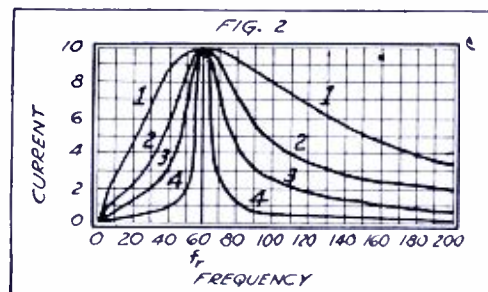

Selectivity vs. the L/C ratio with constant circuit resistance. The higher the ratio, the more selective the circuit becomes.

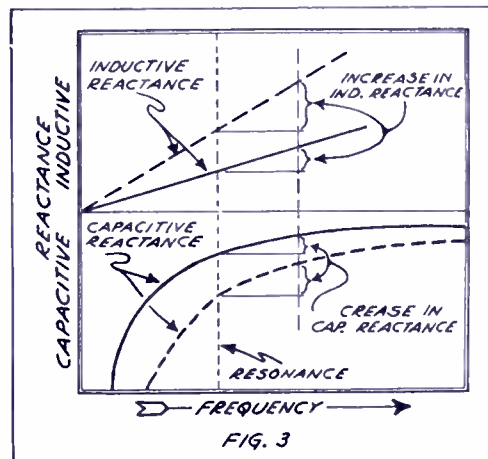

Set of curves which show why the selectivity increases as the inductance used increases, the resonant frequency being constant.

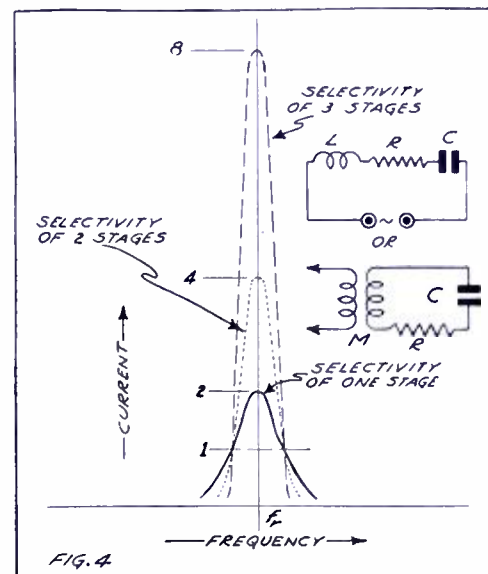

Curves showing that the total selectivity of a receiver is equal to the product of the individual selectivity curves.

sounds pretty obvious, but many will be surprised to know that the average broadcast receiver begins to fall off after 1000 cycles!

Why? There are two reasons: a poor audio system and too much selectivity. The audio system can be corrected for frequency discrimination, but you can't correct the selectivity without damaging the sharp tuning.

Some attempts have been made to use band-pass tuning circuits to regain some of the lost signals, but they have not been popular because of insufficient selectivity and production difficulties—when built to a price.

But leaving aside the question of band passing, it should be quite apparent that a selective set cannot have high fidelity, unless some means be used to correct for the r.f. discrimination in the audio end, which is exactly what is done in the Stenode. The system, however, is costly, and is not warranted in view of the fact that comparatively few broadcast stations at the present time push out enough high fidelity signals.

The Short Waves

This complex situation exists in the broadcast band, but, fortunately, is not important at the present time down below 200 meters. The main problem to be solved on the 49-meter band, for instance, is how to separate one station from another, without any regard to *how well* that station is received. Ease of tuning and little interference, whether image or "adjacent channel," are more important right now than getting a high quality signal saturated with interference.

The happy medium is always a compromise. Right now, on the short waves, we need high-ratio dials and plenty of r.f. And when we can get some of the foreign countries to agree to some sort of "channel" arrangement, it will be high time to think of high fidelity short-wave receivers.

All-Wave Receivers

The last few statements do not hold in the case of all-wave receivers. That this is so becomes evident when it is considered that, at present at least, the short-wave section of an all-wave receiver is considered as a mere by-product, so to speak, and not as a necessary part of the receiver itself. This is true for many, though, fortunately, not all of the manufacturers.

For this reason the broadcast set is designed with an eye to quality and 10 kc. selectivity. A number of commercial receivers tested by your technical director had plenty of interference on the broadcast band; on the short-wave end of the set, tuning was so sharp that it was virtually impossible to find a station, although the clicks and peeps could be heard as the dial was twirled over each band.

—L. M.

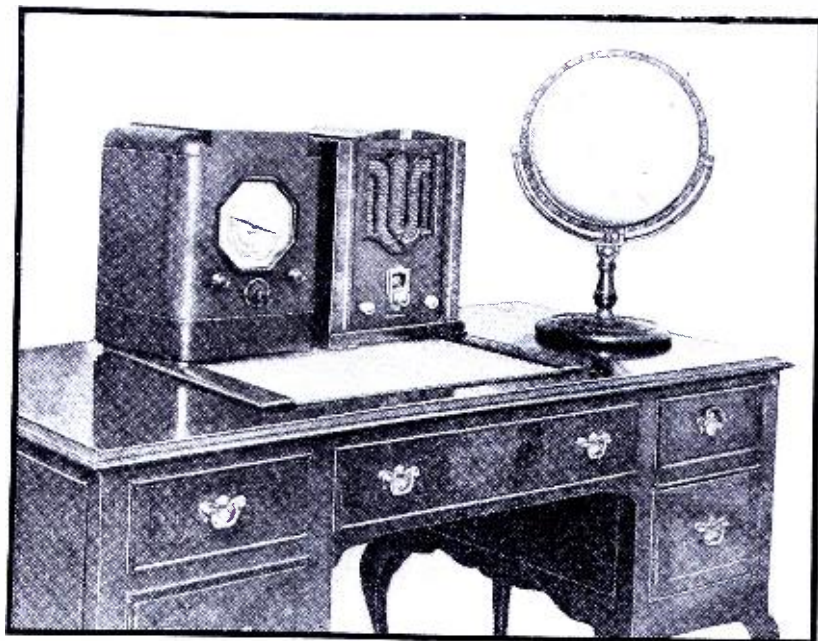

A Technical Discussion of the Stromberg-Carlson 69 S.W. Converter

.....
The converter along-
side a Colonial
model 650 receiver
in operating posi-
tion. We operated
this combination for
about three weeks,
days and nights.
.....

NOTWITHSTANDING the rather extensive use of all-wave and strictly short-wave receivers, there is still a very fertile market for converters. Converter design has made very rapid progress in the last few years. Early models had no preselection and no tuned output circuit. They were noisy, had low gain, and worked in spite of, rather than because of, themselves. These are the main reasons why converters have not, in the past, received popular acclaim. However, in line with the development of all-wave receivers, converters have again come into their own, and we present herewith a description of the Stromberg-Carlson model 69 all-wave selector (short-wave converter), which represents, in our estimation, the last word in modern converter design.

Physical Construction

Let us discuss, first, the physical construction and then turn our attention to an analysis of the circuit itself, which has some very fine engineering features.

The photograph of the converter itself shows an immense dial and three knobs. The entire instrument is 14 $\frac{1}{4}$ in. high, 10 $\frac{7}{8}$ in. wide and 9 $\frac{7}{8}$ in. deep. It is made of five-ply wood faced with American walnut.

The left knob turns the converter on or off—nothing else. The right hand knob is the selector switch (no plug-in coils used, of course). It has four positions, the extreme left disconnecting the converter and automatically connecting the aerial to the broadcast receiver. The next position, going clockwise, covers the band from 1430 to 4200 kilocycles (209.7 to 71.4 meters); the third position, going clockwise, covers the band from 3.7 to 10.5 megacycles (81 to 28.5 meters); the fourth and last position tunes from 9 to 25 megacycles (33.3 to 12 meters).

The dial is very unique. It is composed of concentric octagons graduated in both frequency and wavelength. When the converter is turned

on by means of the left-hand knob, the semicircular ring comprising the left hand section of the dial lights up. This section contains a concise description of the tuning procedure and remains illuminated as long as the converter is turned on. If the selector switch is in the extreme counterclockwise position, then the remaining sections of the dial are dark and the set is ready to receive on the regular broadcast band, the converter itself not being connected in the circuit.

When the switch is turned one notch to the right, the opposite half of the ring lights up, and the 1430 to 4200 kilocycle graduations are clearly visible. The standard broadcast receiver is turned to 545 kilocycles and the selector is tuned for short-wave signals lying within this band.

If the selector switch be turned one more notch to the right, a left hand inner ring of the dial illuminates, and the 3.7 to 10.5 megacycle graduations are clearly illuminated. Likewise, at the extreme right hand position another, opposite right-hand section, showing the graduations of the 9 to 25 megacycle band, illuminates. During these switching manipulations, the circular section giving tuning directions is always lit.

The Tuning Knob

This really sounds much more complicated than it actually works out in practice. Once the converter is hooked up, it merely remains for the operator to flip the selector switch to the proper band, and tune.

Speaking of tuning, we might just as well discuss the proper use of the sombrero-like knob in the center. The wide part, which corresponds to the brim of a hat, is perhaps an inch and a half in diameter, and the smaller, central section, corresponding to the dome, is about a half-inch in diameter. For rough tuning, the "dome" is merely twirled between the thumb and forefinger. For fine tuning, the tips of the thumb and forefinger are used on the "brim." The vernier action obtained by this

latter mode of tuning, together with the mechanical ratio of the gearing system, provides one of the smoothest dials available. It is really difficult to appreciate what can be done with a dial of this type unless one actually sits down at the converter and hunts for stations.

Let us now confine our attention to the schematic diagram. Note that there are four antenna and ground posts at the rear of the set. These are shown in schematic form alongside the diagram of the converter. The connection at A provides for the use for a single long antenna, ordinarily used for standard broadcast reception, for the entire short-wave band. This connection provides that the posts A and AD be connected by a jumper and the posts GD and D be connected likewise. With this connection, and by referring to the schematic diagram, it is seen that for the first short-wave position of the switch, B, the antenna is coupled to the secondary, L3, by means of the choke, L1, the series condenser, C1, and the primary, L2. For the center short-wave position, C, this antenna connects to the primary, L4, which couples to the secondary in use, L5. Likewise, the highest frequency band, D, utilizes primary, L6, with its secondary, L7.

More Than One Aerial

The second mode of antenna connection shown in B is used when two separate antennas are available—a long one and a short one. Again referring to the schematic, we find that the long antenna is used on positions A and B of the selector switch while the short antenna is in use on the two high frequency bands, C and D. (Note that position A corresponds to reception of the standard broadcast waves by the receiver.) The third and last mode of antenna connection shown at C is for the use of a long antenna plus a doublet. As before, the long antenna is in use at positions A and B, while the doublet alone comes in to play for positions C and D.

Another excellent feature of the circuit is the coil-short-circuiting arrangement provided in the selector switch. With the switch in position A, the antenna is connected directly to the broadcast receiver in the usual fashion.

With the switch in position B, secondaries L3, L9, and L17 are used with their corresponding primaries; when set at C, secondaries L5, L11

and L19 are used while the previous secondaries L3, L9 and L17 are short circuited in order to prevent any absorption effects caused by the secondaries and their distributed and associated stray capacitances producing resonance within the band in operation.

In a similar manner, when the D band is in use, all the center secondaries are short circuited. (We might mention in passing here that it would be well for many short-wave receiver manufacturers who use switches to incorporate this simple mechanical, short-circuiting arrangement.)

Another feature of the receiver is the use of the 6A7 pentagrid converter in a fashion not usually found in practice. The more common connection uses one part of the tube as an oscillator and another part as a modulator, the two being electron coupled to produce the i.f. This receiver uses a separate oscillator tube, the 76, the output of which feeds grid No. 1 of the 6A7 through condenser C13. Grid No. 2 of the 6A7, ordinarily the plate of the oscillator section, is connected to grids No. 3 and 5 and is bypassed to ground by C7. This automatically places grid No. 2 at r.f. ground potential. The effect of this connection is to prevent any shift in oscillator frequency due to the presence of the signal on the No. 4 grid.

A brief explanation of this phenomenon might be in order at this

time. Suppose a 6A7 be connected so as to act as both oscillator and modulator as per the specifications given by the tube manufacturers. Let it be further supposed that the oscillator frequency is set and that a signal of varying frequency is impressed on grid No. 4, the input grid of the tube. As the frequency of the signal approaches that of the oscillator, a voltage is induced on grid No. 2 (the plate of the oscillator) of the same frequency as the signal. This voltage, then, has a tendency to shift the oscillator frequency, making it lower or higher, according to whether the signal frequency is lower or higher than the normal os-

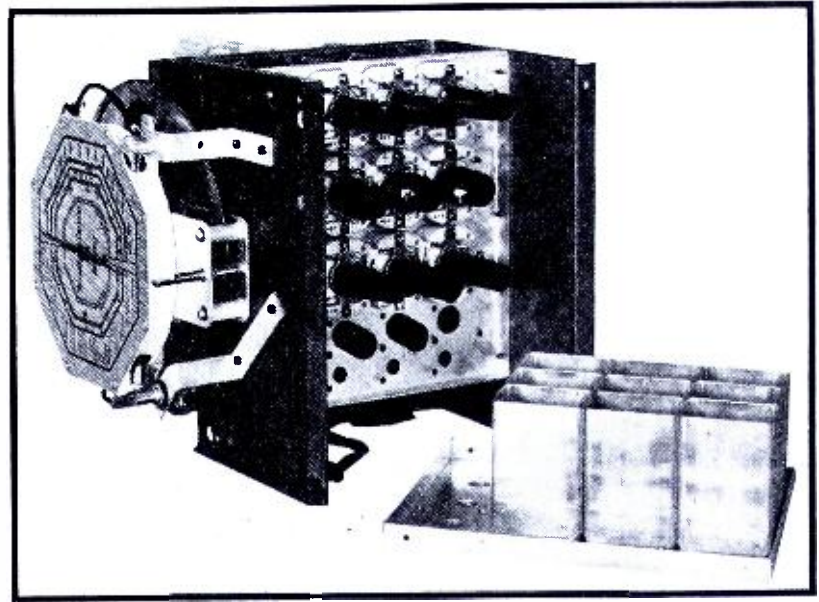

illator frequency fixed by the circuit. One method of minimizing this effect is to place the plate of the oscillator, grid No. 2, at ground potential, so that any induced voltage, mainly by capacitive (condenser) coupling, will not shift the oscillator frequency. Stromberg-Carlson gets around this effect by using a separate oscillator tube and coupling its output to grid No. 1. Since grid No. 1 is interposed between cathode and plate, the oscillator voltage is introduced into the 6A7 in a manner entirely similar to that under more conventional connections.

Another reason for the use of the
(Continued on page 39)

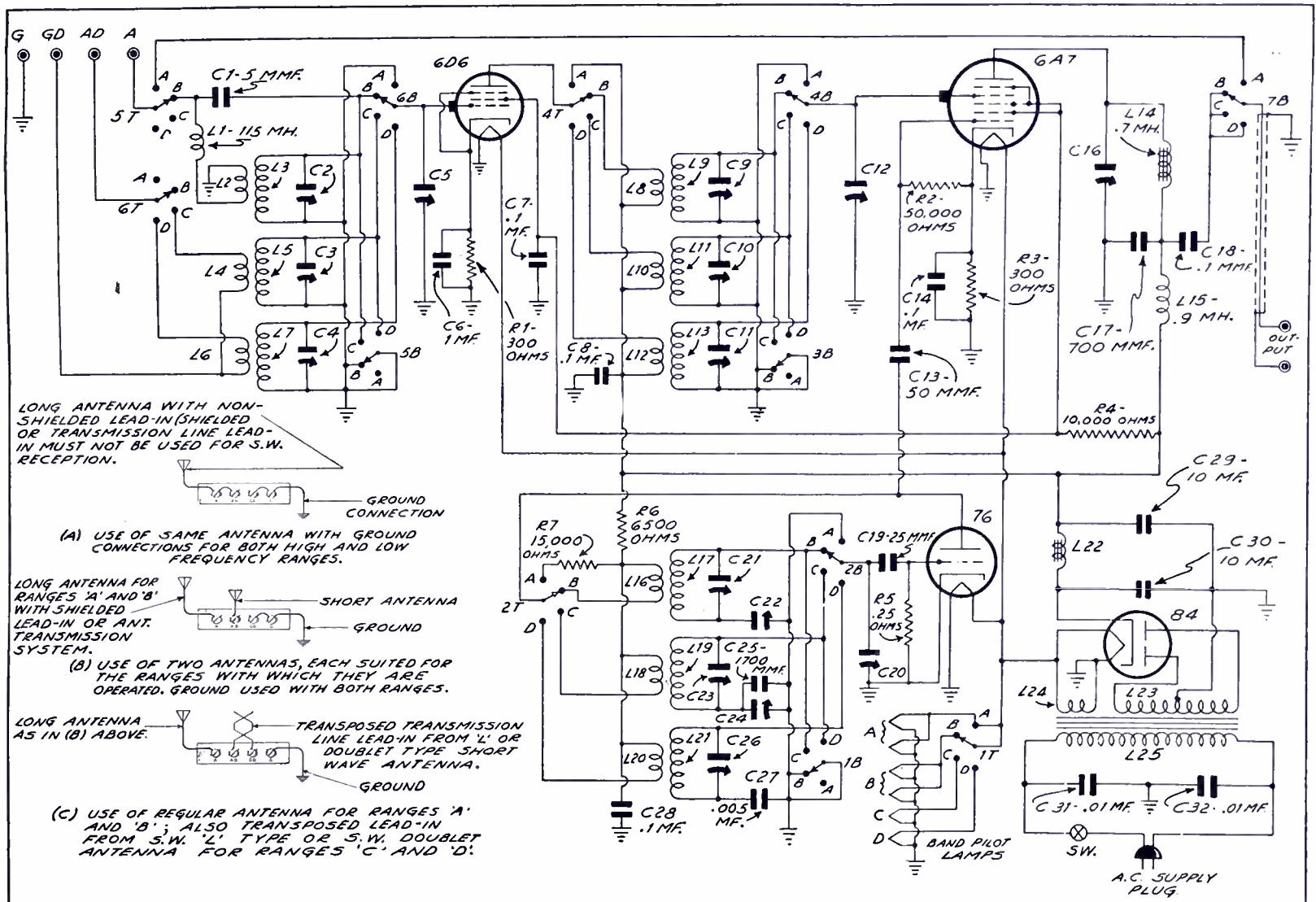

Schematic diagram of the converter with all values marked. A separate oscillator tube is used to provide stability.

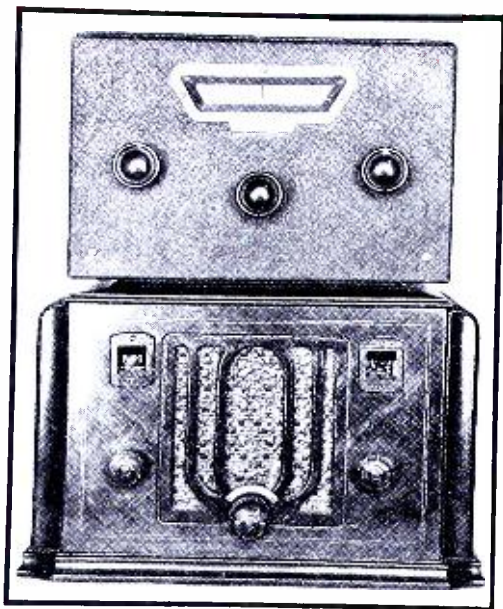

A New S. W. Converter Using Regeneration

SUMMARY: A description of a well-designed converter intended for home construction and maximum efficiency. It has a stage of tuned r.f. ahead of the detector, a capacitance compensation control, and a regeneration control. A unique and valuable feature is that the oscillator works below the signal frequency on certain bands to minimize image interference. Band-spread coil data is included.

By Jay C. Boyd

ONLY a short time ago short-wave converters were regarded as infernal pieces of apparatus which sometimes worked and sometimes did not—frequently the latter.

The idea of converting a short-wave signal into a regular broadcast signal, and then amplifying it on the usual broadcast set, is a practical idea. But why are so many converters unsatisfactory?

The idea is just as practical as it sounds, provided the converter is properly built, is used with a good antenna, although not necessarily an expensive one.

Older Troubles

The trouble with older converters was that they were handicapped by inefficient tubes and poor coupling to the broadcast set. The trouble with many recent converters is cheap construction. Some of them have no tuning whatsoever before their first detectors. This results in an image signal just as strong as the desired signal. Some modern converters are coupled to the broadcast set by means of a single choke and condenser or resistor and condenser. This method is simple, but cannot be expected to give the same results as a tuned output circuit.

Some of the cheaper converters cover the entire short-wave spectrum with two or three coils and then use an ordinary broadcast dial. It takes the sensitive fingers of a safe-cracker to tune these contraptions! It is encouraging to note, however, that some of the better manufacturers are now building some really good converters.

Troubles Overcome

These troubles not only have been overcome in the converter to be described but other desirable features, such as band-spread tuning, the use of a highly selective intermediate stage and tuned output, and volume control conveniently built right into the little black box are employed.

The combination of a good converter and a good broadcast set will give much better results than that which may be obtained by investing the converter's cost in a low-priced, complete short-wave receiver. This combination is also better than some cheap "long-and-short-wave" sets.

Used with a good four-tube mid-get, this combination regularly brings in European and South American stations at full room volume. Australian stations have been heard—but not every time tried for, due to poor atmospheric conditions.

A Practical Converter for Home Construction

The construction of this converter will be described in detail. A 2A7 tube is used for frequency conversion. This is really an oscillator and a screen-grid first detector in one glass envelope. An intermediate stage employing a type 58 tube is used to increase sensitivity and selectivity. The output is coupled through a regular i.f. transformer and coupling condenser, affording additional selectivity and efficient coupling to the broadcast receiver.

The cabinet was obtained from a store on Cortlandt Street, where it was used for a three-tube set of their own design. You can make the chassis from the data supplied or have it made where you buy your aluminum. It is advisable to send your cabinet along with the chassis order, however, to insure a good fit.

Mount all parts on top of chassis and carefully line up the dial and shafts to fit the cabinet. The particular dial shown has an excellent ratio and runs smoothly. Trouble was experienced, though, by having 25-meter stations disappear when the hand was removed from the tuning knob. This was overcome by providing an extra bushing on the cabinet. This bushing is simply an old phone jack with the rear portion sawed off. It is fitted on the cabinet, not on the chassis, which, of course, is grounded.

Pre-Set I.F. Transformers

When the intermediates are purchased, they will be set for 465 kc. This converter is designed to operate at about 600 kc. and the intermediates should be set to approximately this frequency before wiring them in the set. Here is how to do it.

Connect the plate lead of an i.f. transformer to your antenna and the B-plus lead to the antenna post on your broadcast set. Tune in WEAJ and turn up the volume. Now loosen the primary adjusting screw on top of the transformer until WEAJ comes in *weakest*. Repeat this process with the grid and grid-return leads.

You will now have the i.f. units peaked at 660 kc., but when wired into the set, the additional tube and circuit capacitances will change its peak to about 630 kc. Turn each adjusting screw a half turn to right and the peak will be close to 600 kc.

Equalizing Minimum Capacitance In Circuits

Look at the diagram and bottom view of the chassis and you will see an equalizing condenser mounted over the oscillator-grid condenser. What is its function? Referring to a tube manual, you will find the r.f. input capacitance of the 2A7 tube to be 1.5 mmf. more than that of the oscillator. In addition to this, the 50-mmf. padding condenser, C5, has a minimum capacitance of about 5 mmf. Therefore, the minimum capacitance of the detector circuit would be 6.5 mmf. greater than that of the oscillator circuit. When calculating the tuning ranges of the coils, it was desirable that these minimum capacitances be approximately equal. Hence, condenser C6 was added for this purpose.

Now don't worry about not having a capacity bridge to equalize these circuits. Just set this little condenser with the top of movable plate 5/32" open—and then forget it.

Two antenna posts are shown, as well as a third post for the ground. The first two posts are for a doublet connection; if used with a single antenna, one of them is connected to the ground post; the ground post is connected to ground with either type of antenna. If you are not now using a ground on the broadcast set, it may be wise to provide one.

For changing from broadcast to short-wave reception, a porcelain-base knife switch is used. It may be conveniently located in back of the broadcast cabinet.

Any well-filtered power supply giving $2\frac{1}{2}$ volts for the heaters and anywhere from 180 to 250 volts for the plates can be used. Operating the converter from the power supply of the broadcast set is not recommended.

By following the plan given, wiring is easy and chances of error are minimized. First, wire the heater circuit. Put the tubes in the sockets and see if they light. If this tests OK, remove the tubes and proceed. But first, take a pencil and draw a line over the heater circuit in the diagram, showing it is finished.

Next, wire in the negative B lead. In the photograph this is seen coming right down the middle of the chassis, with a "T" connection running left

Deck view of the converter designed by Mr. Boyd. R.F. coil on the left, oscillator coil on the right. Front section of tuning condenser belongs to oscillator, and rear section to r.f. stage. Right-hand i.f. transformer is T2, the output unit. Right-hand front control is for volume and regeneration; the left-hand front control is for capacitance compensation.

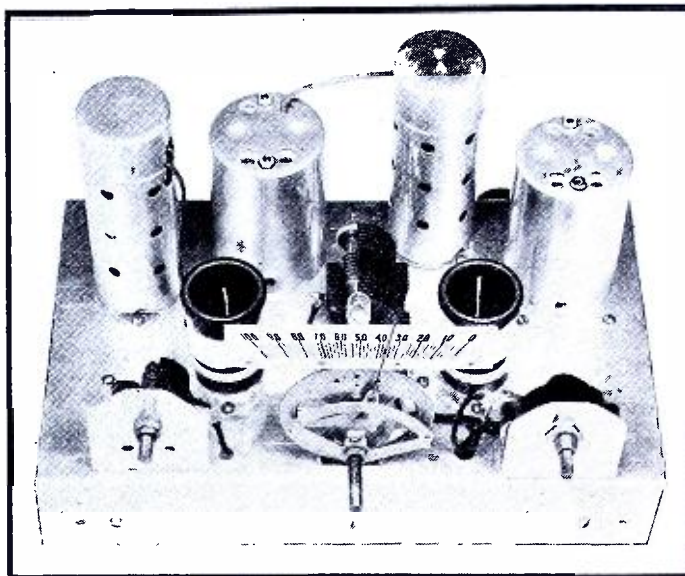

and right, to the coil sockets. A bare bus wire is used here, since several resistors and condensers are returned to this lead, which is also grounded to the metal chassis.

Now, take your pencil and trace over this wire in the diagram. Do this every time you solder a wire, and your wiring job will be finished when you have covered every line in the diagram.

In wiring, it is common practice to begin at the antenna and wire

straight through the diagram from left to right. However, it is more convenient to leave out the resistance bank until all radio-frequency circuits are in, as it allows more freedom in placing short leads in the r.f. circuits. When wiring the resistors, short leads are not so important since they are bypassed anyway.

Leave out all bypass condensers until everything else is wired; they only get in your way. These are

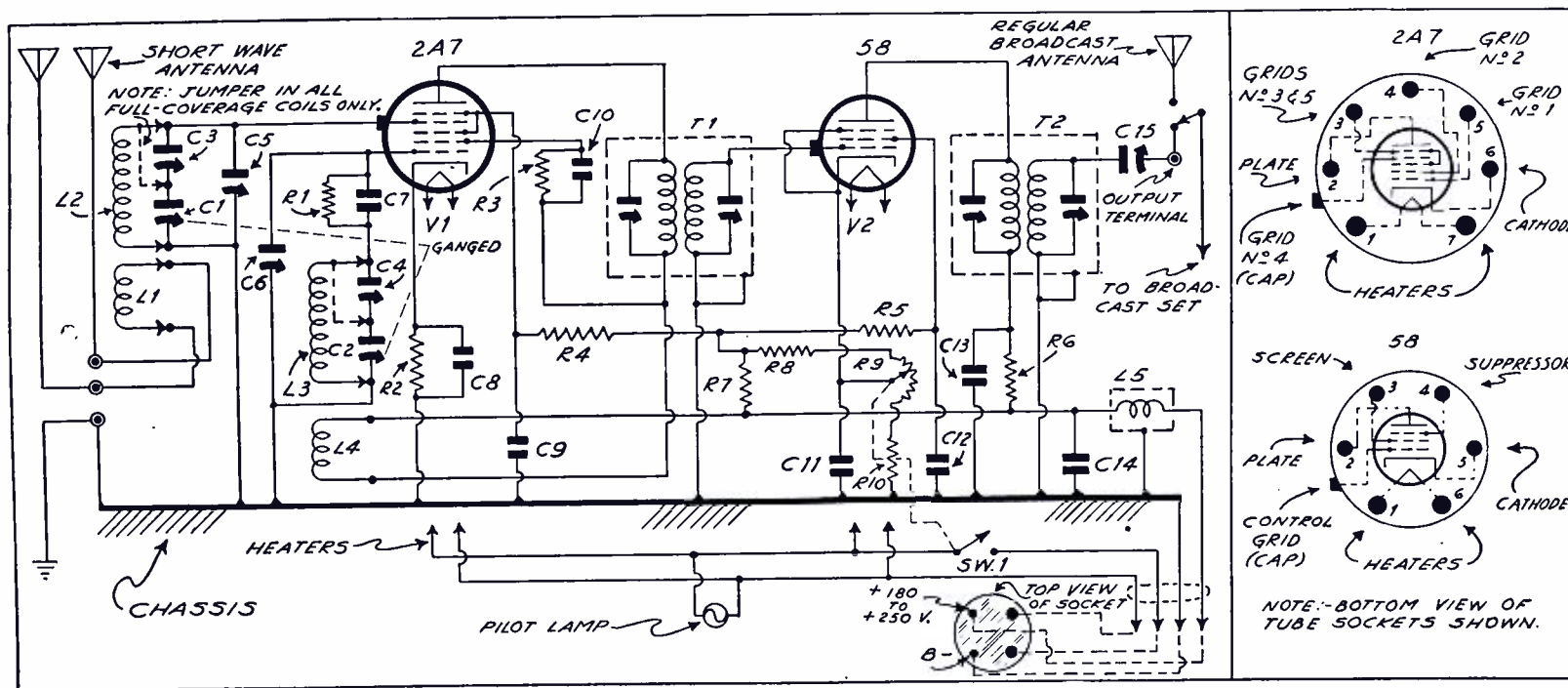

Schematic circuit of the converter. Coil data for band-spread and complete coverage is included.

Parts Required

- L1, L2, L3, L4—Coils as per table. Wound on 5-prong, 1 1/4-inch diameter, Na-Ald Coil forms.
- L5—10-Millihenry shielded r.f. choke, Hammarlund.
- C1, C2—Hammarlund two-gang 100-mmfd. tuning condenser.
- C3, C4—series band-spread condensers, 70 mmfd., Hammarlund.
- C5—Pilot 50-mmfd. Do not use smaller size.
- C6—35 mmfd., minimum capacity equalizing condenser, Hammarlund.
- C7—100 mmfd. oscillator grid condenser, Pilot.
- C8, C9, C10, C11, C12, C13, C14—.01 mf. bypass condensers.
- C15—output coupling condenser, Pilot 50-mmfd.
- R1—oscillator grid leak, Lynch 50,000-ohm metalized resistor.

- R2—mixer cathode-bias resistor, 250 ohms, Lynch.
- R3—oscillator anode-grid voltage-dropping resistor, 40,000 ohms, Lynch.
- R4—screen resistor, 10,000 ohms, Lynch.
- R5—screen resistor, 7500 ohms, Lynch.
- R6—plate resistor, 1000 ohms, Lynch.
- R7—screen voltage dropping resistor, 30,000 ohms, Lynch.
- R8—bleeder resistor, 10,000 ohms, Lynch.
- R9—Centralab 10,000-ohm Elf potentiometer, with switch, SW1.
- R10—Ohmite, 1-watt, wire-wound, 100-ohm limiting resistor.
- T1, T2—Hammarlund i.f. transformers, type T-465.
- SW2—Porcelain base, s.p.s.t. changeover switch, mounted externally. Use d.p.d.t. if broadcast antenna is used for short waves.
- V1—type 2A7 tube. V2—type 58 tube.

- 1—grid-leak mounting.
- 2—five-prong cinch sockets.
- 1—small-base, seven-prong cinch socket.
- 1—six-prong cinch socket.
- 1—four-prong speaker plug and 4-wire cable.
- 1—Crowe full-vision dial, with pilot light.
- 1—old phone jack for above. See text for explanation.
- 3—1 3/8" knobs.
- 1—small knob for coupling condenser.
- 2—aluminum tube shields.
- 4—binding posts.
- 1—Thor resistor mounting strip; or, make from strip of bakelite and soldering lugs.
- 1—chassis of 14-gauge aluminum.
- 2—aluminum brackets for C5 and R9.
- 1—bracket for two-gang condenser if latest type (designed for single-hole mounting) is used.
- 1—cabinet, Alan.

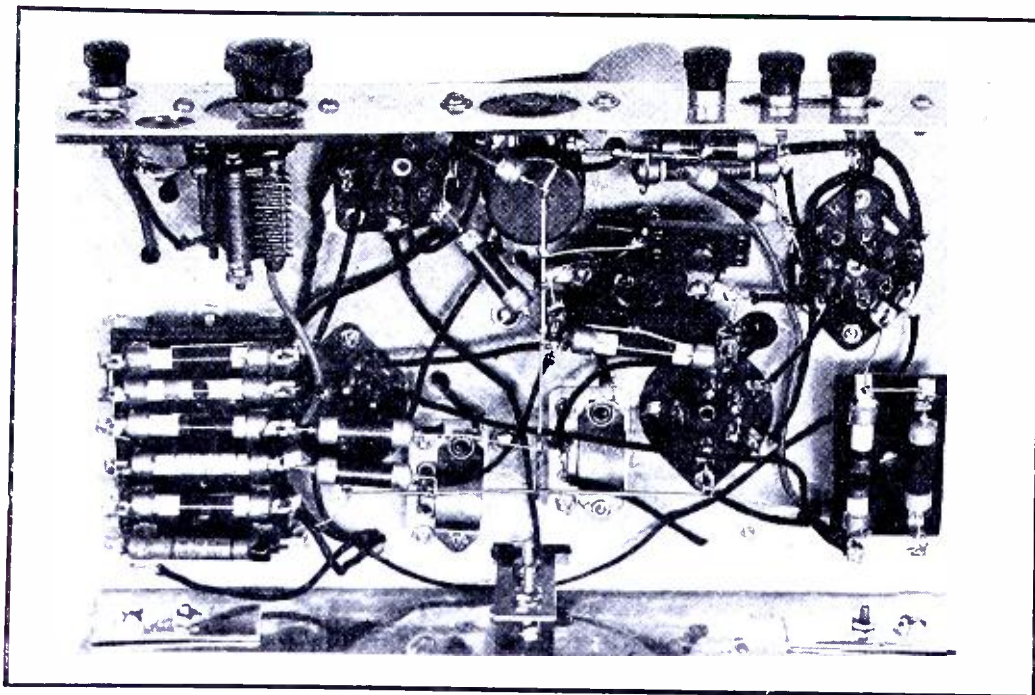

Under view of the converter showing the resistors. C15 is in upper left corner.

suspended in air, hanging by their pigtails to the nearest point on the bare negative B lead.

Check over the job to see that all connections are tight. Check the tube and coil socket connections carefully with the socket sketch. Don't mistake a *bottom* socket view for the top. Also look for any blobs of solder that may have fallen where not intended.

Coils and Tracking

Some readers may wonder if standard ready-wound coils cannot be used. No, they cannot be if you want really good tracking. It is necessary that the oscillator coils be either larger or smaller than the detector coils; not the same size. For receiving a 6000 kc. (50 meter) signal, for instance, the detector is tuned to that frequency, but the oscillator must be tuned to either 5400 or 6600 kc.

The oscillator may be operated at either the higher or lower frequency, as one chooses. An advantage gained by operating the oscillator at a *lower* frequency than the detector circuit is that the chances of getting image interference on the 49-meter band is less. Converters with oscillators operating at a higher frequency have their 49-meter image falling right in the middle of the busy 40-meter amateur band, which may cause serious interference if there are powerful "ham" stations in the vicinity.

If the oscillator is operated at a *lower* frequency (higher wavelength), as in this converter, the detector coils will be smaller, and will require padding to limit their tuning range. Since a manual trimming condenser is desirable, this same condenser, C5, will also serve as the padding capacitance. The coils have been so proportioned that very good tracking is obtained from 0 to 100 on the dial. The padding condenser is changed very little, except when changing coils.

There is one exception to what has been said about tracking. When using the largest set of coils, the padding condenser must be changed every time the tuning dial is changed 20 divisions or more. This is because the oscillator coil is *smaller* than the detector—just the reverse of other coil sets. This keeps the oscillator from operating in the broadcast band, as well as avoiding image interference from local broadcast stations.

It is preferable to wind the antenna and plate coils first. Leave 3/16" space and then wind the grid coils. In the case of oscillator coil B, there isn't any space to spare, so that it is best to wind this grid coil first, beginning at the top.

Note that a jumper wire *must be inserted* in all full-coverage coils, but is *omitted* in all band-spread coils. This jumper goes from the center prong to the grid prong in all cases. When coils having these jumpers are

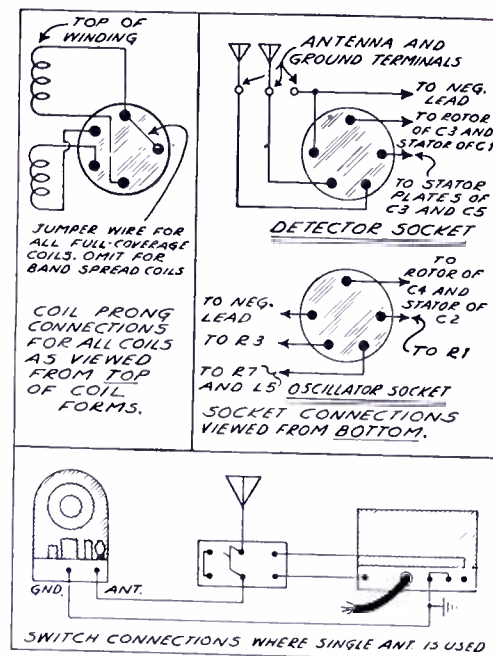

Diagrams showing the connections of the coils to sockets and use of single aerial.

inserted, the band-spread condensers C3 and C4 are shorted out.

All coils must be wound in the same direction and leads must be brought out to *proper* prongs, as shown in the sketch. After winding, the coils are given a thin coat of clear Duco or National coil cement. The smaller detector coils should not be cemented until later.

Don't wind the band-spread coils until you are entirely familiar with the converter and until you can find your way among the short-wave stations.

Operation

Put the A-band coils in their respective sockets and connect the power supply and antenna. Run a wire from the output binding post to antenna post on the broadcast receiver and set the coupling condenser C15 about a quarter in mesh. (Continued on page 41)

COIL DATA FOR FULL-COVERAGE COILS

B'nd	Wave Coverage (Meters)	Secondary - L2			Primary - L1		Oscillator Grid - L3			Plate Coil - L4	
		No. Trns	Wre Size	Length Winding	No. Trns	Wre Siz.	No. Trns	Wre Size	Length Winding	No. Trns	Wre Size
A	105-214	49	32	13 16"	15	32	36	32	5 8"	15	32
B	65-115	29	22	1 1/8	12	28	43	22	1 9/16	12	32
C	42-70	17	22	1 3/16	10	28	21	22	1 11/16	10	28
D	26-45	10	22	7/16	8	28	11	22	7/16	8	28
E	18-28	5 1/2	22	1/4	4	28	6	22	1/4	5	28
F	12-20	3 1/4	22	1/4	3	28	4	22	1/4	4	28

COIL DATA FOR BAND-SPREAD COILS

G	45-54	20 1/2	22	1 3/16	7	28	26 1/2	22	1"	8	28
H	24-28	10	22	1/2	4	28	11	22	1/2	5	28
	27-32										

All coils wound with double-cotton-covered wire (d. c. c.).

All secondary and oscillator grid coils are close wound. "Length winding" indicates space between holes for convenience in drilling forms. Actual windings are sometimes slightly less. Primary and plate coils are close wound, except on E, F, and G coils, where they are slightly spaced to fill 3 16".

Space between windings is 3/16 inch, except B oscillator, which is 1/8 inch. Coil forms are 1 1/4" in diameter.

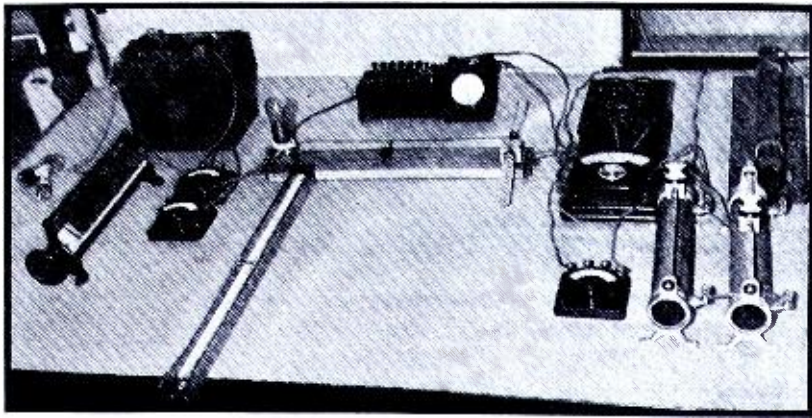

Experimental set-up of a 75 cm transmitter designed by the author.

How to Build a $\frac{3}{4}$ -Meter Transmitter

SUMMARY: Complete constructional details of a 75 cm transmitter and receiver. No theory whatsoever is included; this is a simple, practical article dealing only with the construction and operation of the sets.

By John L. Rennick

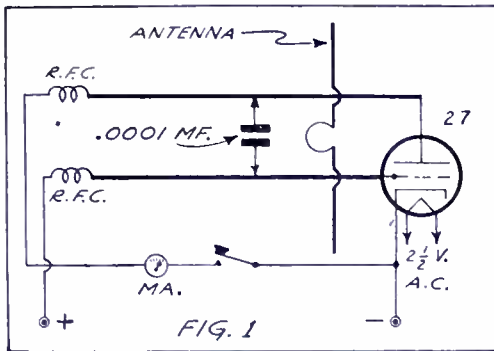

Fundamental circuit of the transmitter, which may be built with comparative ease.

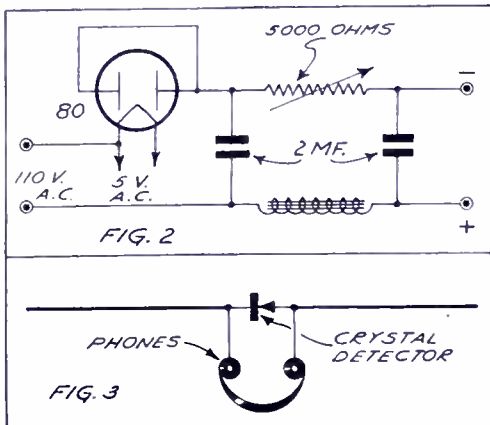

Schematic circuits of the power pack and receiver employed by the author.

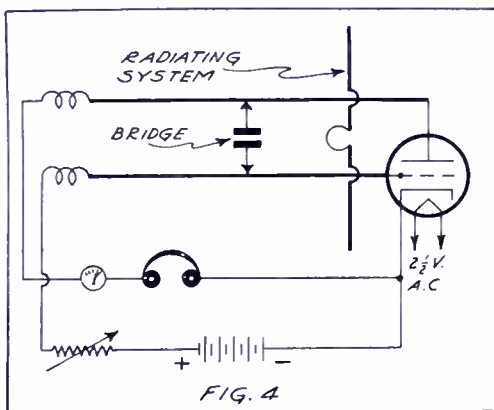

Diagram of a simple one-tube receiver, which may replace the crystal set shown.

NEVER be afraid of a name. Whether you call them Gill-Morrell, Barkhausen-Kurz or Quasi-Optical oscillations, they are still radio waves, and, as such, should hold no terror for the ordinary radio amateur and experimenter. To be sure, the mechanism of the oscillations involves certain novel and rather intricate physical concepts, but it is not necessary to

understand these in order to put a transmitter and receiver into operation.

The circuits are laughably simple. The necessary equipment is in every experimenter's junk box. A type 27 tube, a suitable socket, a heavy duty 5000-ohm variable resistor, a few small stand-off insulators, some odds and ends of wire, and a low-range milliammeter make up the transmitter. The receiver may well be a duplicate of the transmitter with a phone connection added.

The Transmitter

The transmitter is first constructed according to the drawing and photograph. The parallel wires are spaced about 3 inches, and should be of rather heavy copper. Number 8 was used by the writer. The radio-frequency chokes are wound of the same size wire on a form $\frac{1}{2}$ inch in diameter. Twelve turns spaced $\frac{1}{2}$ inch apart should be sufficient. The condenser bridging the resonating wires is a .0001 mf. mica bypass condenser arranged so that it may be moved along the wires. The meter in the plate circuit is really necessary, and should have a full-scale deflection of not more than 5 milliamperes. If a 1000-ohms-per-volt meter is available, it may be used on the 6-volt scale. A 0-200 ma. meter in the grid circuit is helpful but not necessary.

Since voltages in excess of 125 volts may not be used safely on the grid of the 27 tube, no step-up transformer in the power supply is necessary. The omission of a transformer at this point improves the regulation, which is a distinct advantage. The filter choke should be of low resistance and capable of handling currents in excess of 200 milliamperes.

Selecting the Tube

A word about the selection of a tube is now in order. It should be remembered that the frequency of oscillation is a function of the tube dimensions. For this reason, a tube of reliable make should be used and care should be taken to see that the elements are not displaced. Gas is not to be tolerated, but low emission is an advantage. If a type 27 is not available, a 56 may be used, although the former is preferable.

To test the transmitter, connect the power supply and apply about 50 volts to the grid of the tube. While watching the plate milliammeter, slowly slide the bridging condenser away from the tube. A point should be reached where the plate current suddenly increases from a negligible value to from 500 to 1000 microamperes. As the condenser is moved still farther from the tube, the plate current will drop to its former value. At a grid potential of 50 volts, the waves should be within the 75 centimeter amateur band. The wavelength may be roughly calculated from the grid voltage by using the formula:

$$\lambda = \frac{525}{\sqrt{E_g}}$$

λ = wavelength in cm;
 E_g — Grid voltage

This equation applies only to type 27 tubes, and is only approximate, since the value of the constant varies with individual tubes. For this reason, it is advisable to build a wavemeter. A piece of heavy copper wire about 5 feet long is doubled at the middle and supported by bakelite or porcelain insulators in such a manner that a wire bridge may be slid along the wires short-circuiting the open end. To use the wavemeter, place the looped end close to the transmitter wires with the latter in operation. (See the photograph.) Adjust the bridge condenser on the transmitter so that the plate of the tube draws the maximum current, and then slide the wavemeter bridge away from the closed end until there is a slight dip in the plate current. Mark the position of the wavemeter bridge. Continue to slide the wavemeter bridge until another dip occurs. Measure the distance between the two positions where the dips were noticed. This distance is equal to one-half the wavelength.

With the transmitter oscillating properly, it is time to arrange a radiating system. Stiff wires about $7\frac{1}{4}$ inches long may be clipped to the grid and plate terminals of the tube or connected to a half turn of wire coupled to the resonating wires

(Continued on page 40)



Building and Operating A Good 2-Tube Preselector

SUMMARY: Here is a preselector that should appeal to the man who wants efficiency plus. It has two tubes, regeneration in the r.f. stage, is powered from the receiver with which it is used, and really pre-selects. It earned its spurs in a recent demonstration to the editors of *SHORT WAVE RADIO*. The author is shown convincing your technical director (also seated).

By B. Herbert Russ *

THE desire always manifests itself among short-wave listeners and "hams" to increase the signal strength of some weak phone, c.w. or foreign broadcast signal. This desire can be satisfied to some extent by special expedients, such as tuning the antenna, special antennas, etc. All such types of "gadgets" do in effect increase signal strength but never to a marked degree.

Comparatively speaking, our present-day receivers are of a high order of sensitivity and selectivity. An "old timer" need look back but a few years to realize this great advance in receiver design and operation.

The quality and quantity of a signal emanating from the "cans" or loudspeaker is the sum total of the efficiency of the components comprising our particular type of receiver, be it a superhet or autodyne. Paramount to all of this is the amount of carrier that finds its way to the receiver input. The greater the signal input the greater the signal output and vice versa. No matter what the amplitude of the signal at the input of the receiver, its resultant output is determined by the overall efficiency of the receiver proper. However, for a given signal, we can vary its output over a wide range by the controls on the receiver, i.e.: r.f. or i.f. control, input or output controls; but how about increasing the "hop" after all the controls are wide open?

Pre-amplification

Pre-amplification, with its inherent pre-selection, is the only known method today of accomplishing our desired result. It does this to the extent of a very marked increase in overall gain. The word "pre-amplification" is almost self-explanatory. Pre-amplification is that process whereby a feeble radio-frequency voltage (picked up via the antenna) is increased in magnitude, by virtue

of the associated circuits, in the pre-amplifier.

Pre-selection, which is a characteristic produced by pre-amplification due to its highly resonant circuits, is that definite and highly desirable characteristic of selecting a signal of a particular frequency, and discriminating against signals of frequencies other than the desired one. Thus, by pre-amplification and pre-selection we have at once accomplished several important and desirable results:

1. Very substantial increase in signal gain.
2. Consequent increase in sensitivity.
3. Rejection of image or repeat spots.
4. Considerable increase in selectivity.
5. Reduction of noise-to-signal ratio.

For easier reading purposes, let us call the unit we are dealing with a preselector; while also bearing in mind the fact that pre-amplification of the highest order takes place.

We have at this point accomplished our much desired purpose, that is, of taking the feeble signal from the antenna and increasing its magni-

tude to a much greater extent than it would ordinarily be if fed directly into our receiver.

Our particular unit comprises two tuned stages. Now, with the same number of stages, if we could increase its effectiveness to the extent of another one or two stages, making the overall preselector an equivalent of three or four stages, then we will have literally raised our receiver far above its class. This can be accomplished by the proper use of regeneration.

Regeneration Used

Looking back over radio history, we find that regeneration has been one of the greatest developments in radio, and still remains so today. The technical definition of regeneration follows: "the process by which a part of the output power of an amplifying device reacts upon the input circuit in such a manner as to strengthen the initial power, its result being an increase in amplification."

With the addition of a variable regeneration control we have a pre-selector and pre-amplifying device that delivers the peak of performance. Such a unit, known as the Peak P-11, has recently been brought out.

The P-11 is contained in a heavy gauge steel black-crackle finished cabinet, 7 $\frac{1}{4}$ x 9 $\frac{1}{4}$ x 10 inches. It covers all wavelengths with ample overlap from 14 to 200 meters with three sets of built-in coils, thus doing away with the undesirable "plug-in" method. The obvious convenience of this switching system brings itself to the fore when one is DX-ing over a wide range of frequencies.

The unit utilizes two tuned stages of high gain type 58 tubes, the first stage being electron-coupled regenerative. Electron coupling lends greatly to stability in operation. The regeneration control is, of course, variable to obtain maximum gain. This control, if advanced past the



View of the preselector described here. The regenerative stage certainly does increase the gain of the first stage.

* Chief Engineer, Eastern Radio Spec. Co.

point of maximum regeneration, will allow the first stage to oscillate; it is used at the point just before oscillation occurs, never in the oscillatory position. The gain is very high at the point of maximum regeneration, but falls off after oscillation sets in.

The tuning unit is the popular illuminated airplane type dial with black background and white gradations and pointer. The escutcheon is oxidized silver. The smooth working regenerative control is the lower left-hand knob. The center control is the changeover switch. On the right is the double-pole, double-throw quarter turn on-off switch. This latter switch in the off position throws the antenna from the preselector to the receiver proper. The unit contains its own filament supply and it is only necessary to tap the positive plate supply from the receiver with which it is used for operation. The B plus may be obtained from any point at the filtered side of the plate supply. The negative connection can be obtained from the chassis or ground terminal on the receiver. Any B voltage between 150 to 300 volts may be used. Of course, a separate plate supply may be used but is not necessary.

Operating the Unit

Now we'll get down to business and hook the preselector unit to our receiver and note results. Looking at the terminal strip at the rear we find the posts reading from left to right, RG, AR, B plus, B minus, AG, and A. The hooking up should be done with the receiver's and unit's switches in the "off" position to avoid possible shock. Disconnect the antenna and ground from the receiver. Place the antenna on post A of the preselector and ground on terminal AG. If a doublet is used, its leads connect to A and AG; the ground, if one is used, remains on any point on the metal chassis of the receiver. In practically all receivers the ground post will suffice as the B minus contact. The B plus connec-

tion is made as described previously.

Posts AR and RG are connected together at the terminal strip and the same wire goes to the antenna post on the receiver. At this time, it is necessary to inform the reader that in several instances, even higher gain was apparent by connecting terminal RG directly to the grid cap of the first detector in superhets or to the grid cap of the r.f. tube in supers and ordinary t.r.f. jobs. In this case the small compression type trimmer condenser is placed in series with the grid lead and as close to the grid cap as possible. However, if this type of coupling is used, terminals AR and RG are *not* connected together. Terminal AR still remains connected to the antenna post of the receiver. Mention must be made of the fact that if the receiver has the doublet antenna strip, that is, if the receiver itself has terminals marked G, A, A, a jumper is always connected between G and one of the A posts. All leads should be made short as possible, using insulated wire.

Our first test was made with the Hammarlund Comet Pro. The P-11 preselector was hooked up and the switch left in the off position. Amateur fone, c.w. signals or foreign broadcasts were tuned in in the usual manner, signals chosen being of the R3 to R5 audibility. The switch on the P-11 was thrown on and a few moments allowed for the tubes in the preselector to warm up. Tuning in the signal on the P-11, the gain control was slowly advanced until the signal reached its greatest strength. A minor tuning adjustment was made. Lo and behold, these same signals of the R3 to R5 variety were boosted to R9 and R9 plus, some sig-

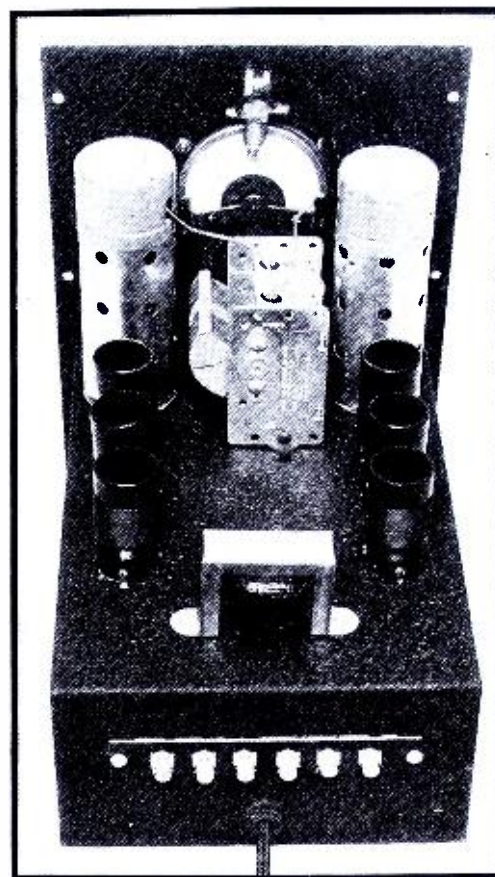

A view behind the panel. The coils and neat parts arrangement is evident.

nals even being so strong as to block the second detector, necessitating lowering of the gain control in the receiver.

Similar results were had on the National, The Patterson All-Wave PR-10 and several varieties of home made sets. Once connected, the P-11 need not be disconnected, as the on-off switch accomplishes this. Here is a pertinent feature—extremely weak stations that were not readable be-

(Continued on page 38)

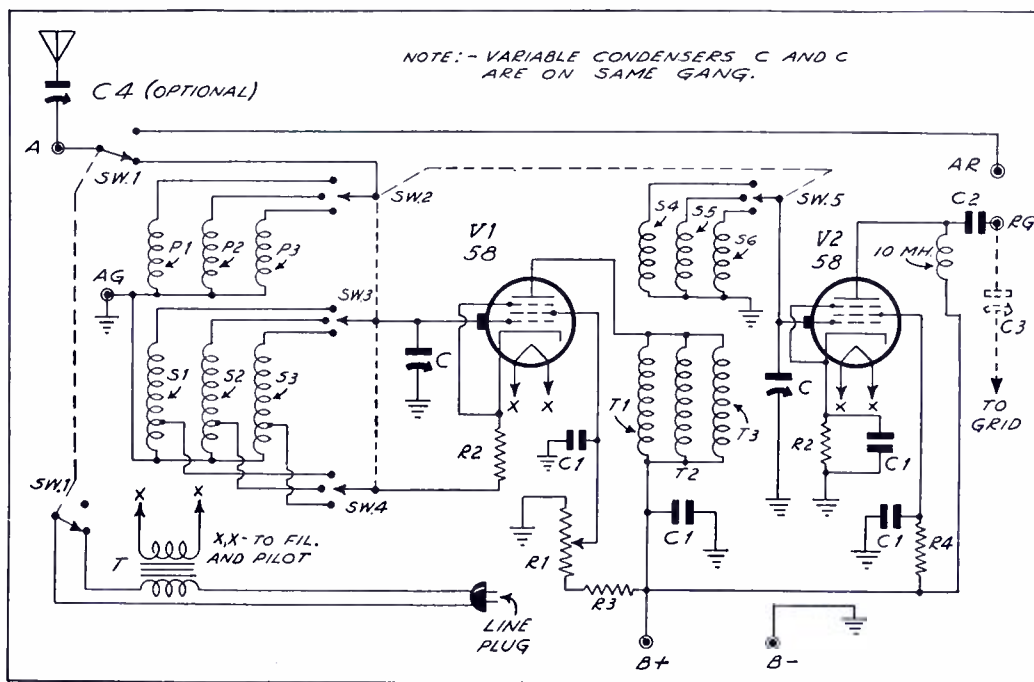

Circuit of the preselector. The list of parts is below; coil data, to the left

C—350 mmf. dual gang variable condenser.
 C1—four .1 mf. bypass condensers.
 C2—1000 mmf. mica condenser.
 C3—compression type trimmer condenser (optional).
 C4—50 mmf. variable condenser.
 R1—50,000-ohm potentiometer.
 R2—Two 300-ohm bias resistors.

R3—25,000-ohm voltage dropping resistor.
 R4—75,000-ohm screen resistor.
 T—2½ volt, 3 ampere filament transformer.
 SW1, SW1—double-pole, double-throw on-off switch.
 SW2, SW3, SW4, SW5—4 gang, three position coil-selector switch.
 Cabinet, binding-post strip, dial, wire, etc.

COIL DATA TABLE

Winding	No. of Turns	Size Wire	Tap From Bot.
P1 } Primaries	15	34 enam.	
P2 } 1st Stage	7	34 enam.	
P3 } 1st Stage	4	34 enam.	
S1 } Secondaries	40	26 d.s.c.	5
S2 } 1st Stage	12	26 d.s.c.	2½
S3 } 1st Stage	6*	26 d.s.c.	2½
T1 } Primaries	30	34 enam.	
T2 } 2nd Stage	30	34 enam.	
T3 } 2nd Stage	30	34 enam.	
S4 } Secondaries	40	26 d.s.c.	
S5 } 2nd Stage	12½	26 d.s.c.	
S6 } 2nd Stage	7*	26 d.s.c.	

*Space wound 1-16" between turns. All other windings are close-wound. Spacing between antenna coils and secondaries are 1-8". Spacing between plate coils and secondaries are 1-16". All coil forms are 1" in diameter.

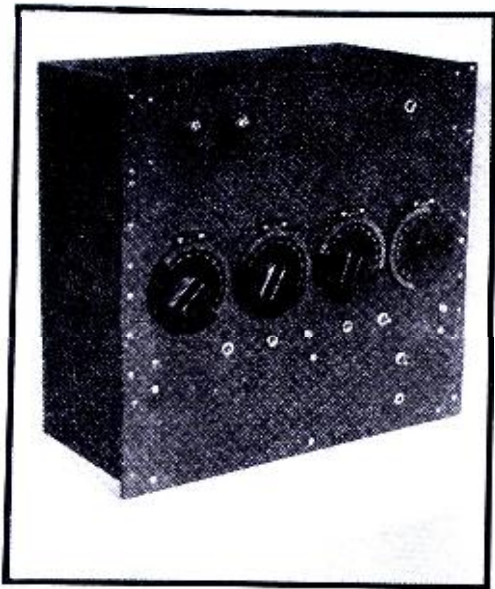

Panel view showing controls and jacks.

SUMMARY: *One dollar a watt. That is what the author claims this transmitter will cost the prospective builder—without sacrifice in quality, either. Complete constructional data are included in this article to enable anyone familiar with diagrams to get it working. All parts are standard, the panel may be obtained ready drilled and finished, all ready for assembly.*

It is so constructed that it is an easy matter to add units as the purse grows until the maximum input of 1 kw. allowed amateurs is reached.

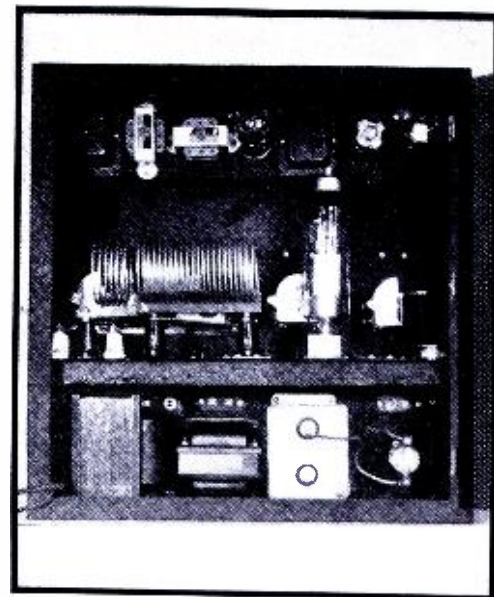

Rear view showing the parts arrangement.

A 100-Watt Phone Transmitter

By **McMurdo Silver**

TWO things are outstanding about amateur radio telephony: the small number of phones in operation as compared to telegraph transmitters, and the unintelligible hash, called modulation, put out by the great majority of these amateur phones.

The primary reason for both these conditions is cost, for almost any amateur would rather communicate by voice than by code. Because the only really satisfactory method of modulating a telegraph transmitter for phone operation in the past has been by plate modulation, it has been necessary to develop half as much audio power as was supplied to the final r.f. amplifier stage for efficient modulation. This has necessitated complicated, multi-stage audio power amplifiers, the cost of which almost invariably exceeds that of the telegraph transmitter itself. The complication of such audio amplifiers accounts for the hash radiated by many existing amateur phones, and, likewise, for the cost that has made them so unpopular.

The Present Picture

This whole picture is now completely changed, thanks to the genius of Dr. Paul T. Weeks, of the Raytheon Company, and James Lamb, of *QST* and it is now not only possible to build an amateur phone boasting good broadcast-station modulation quality, but such a transmitter today can be built at a cost equal to or lower than that previously possible for a telegraph transmitter of equal power. There is now no excuse for hash instead of quality in amateur phone modulation, for any amateur who can build a receiver can build a thoroughly excellent hundred-watt phone for a little over a dollar a watt of antenna power—or buy it complete and ready to operate for a dollar and a half a

watt! He may then grow up sensibly and easily to the one kilowatt maximum input allowed if he wishes to do so.

This is made possible by suppressor-grid modulation in the new RK20 Raytheon screen-grid r.f. pentode. Previous articles have described this tube and its mode of operation, which may be summarized by stating that less than one watt of audio power is required to obtain 100 per cent modulation for its 100 to 120 watt r.f. output with quality equal to that of the best broadcast station. This is made possible by control of the suppressor-grid voltage, variation of which gives a linear control of r.f. power output. But the purpose of this article is not to describe the tube, but rather its practical application in a 100- to 120-watt amateur radiophone of excellent quality, yet ridiculously low cost.

The transmitter illustrated in the photograph and diagram employs one RK20 in a crystal controlled Tritet electron-coupled oscillator circuit and delivers 100 to 120 watts of r.f. power on any amateur band, for either c.w. or 100 per cent modulated telephony. Modulation is effected through a simple two tube, three stage audio modulator and microphone. For full 100 watt output, a total of five tubes are used, costing exactly \$25.23 for all five. Veritably, it is a dream come true; for, with tubes and crystal microphone, the whole cost is only about \$160.00.

The transmitter is seen to consist of three units mounted on three standard 19" crystalline black 3/16"-thick aluminum relay rack panels, having a combined height of only 17½". The lower unit is the r.f. power supply, the next is the 100-

watt crystal oscillator, amplifier and antenna tuner, and the top unit is the modulator.

Starting with the r.f. unit, one of the new RK20's is used as an electron coupled (Tritet) crystal oscillator and amplifier. The crystal is connected between grid and filament, and the oscillator "plate" tank circuit between filament and grounded screen, thus making up the triode oscillator circuit. Despite the power developed, the crystal is subject to less strain than in the ordinary low-powered crystal oscillator, due to the high μ of the RK20, which is so high that, as an r.f. amplifier, it requires less than a watt of r.f. driving power for full output. The "plate" circuit of the oscillator consists of two coils effectively in parallel, tuned by a 365 mmf. condenser. Since the RK20 is a filament tube, and since the filament of an e.c. oscillator must be above ground, these two coils are included, one in each side of the filament circuit, and serve both as r.f. chokes and as oscillator "plate" inductances. They are wound on a plug-in form to permit interchanging for quick shift to operation on 10, 20, 40, 80 or 160 meter amateur bands.

Checking Operation

Oscillator operation is checked by a "plate current" jack in the screen circuit, which is bypassed to ground for r.f. currents.

Because of the effective screening and isolation of the oscillator grid and plate circuits from the plate circuit of the RK20, it is possible to operate the oscillator and output circuits at the same frequency, or where operation on two or more bands with only one crystal is desired, to double the frequency in the plate circuit.

The output plate circuit is the standard low C of r.f. amplifier

practice, using a 150 mmf. tuning condenser with plug-in inductance wound with $\frac{1}{8}$ " copper tubing. A jack is provided in the r.f. plate return lead for plate current check. To keep this jack at ground potential, it is connected in the cathode circuit; a meter plugged into this jack will then read both plate and screen current; so that, to determine the plate current alone, it is merely necessary to subtract the previously measured screen current from the total current reading.

Antenna Coupling

Antenna coupling is accomplished by means of a copper tubing antenna coil with variable coupling to the plate inductance. Two 365 mmf. condensers are provided for series antenna tuning, while both may be connected across the feeders for parallel tuning by simply shifting two links on standoff insulators.

The r.f. unit is complete, including antenna tuning circuits, unlike other transmitters available today, and includes a switch to shift the suppressor grid from the modulator for phone operation to 45 volts positive for c.w. operation.

Frequency stability is what is to be expected from crystal controlled operation—modulation causing no appreciable frequency shift. Operation and tuning up is childishly simple with the aid of a single 0-150 ma. milliammeter. Power output with one RK20 is safely 100 watts on the crystal fundamental, but can be pushed up to 120 watts. It is about 60 to 70 watts on the crystal second harmonic. One pair of plug-in coils allows operation on 80- and 160-meter amateur bands, and a second pair of coils permits operation on the 20- and 40-meter bands.

R.F. Power Supply

The r.f. power supply is simplicity itself: one large power transformer providing all filament and plate voltages; an RK19 high vacuum, low-voltage-drop rectifier tube; a high inductance, low resistance filter choke; and an 8 mf. 1500 volt Pyranol oil condenser. The filter is choke input for good voltage regulation and long rectifier tube life. The power unit is provided with an on-off switch and jack, J3, for the telegraph key, which must be short-circuited (or plug pulled out) for telephone operation. This power supply develops 1400 volts at 150 ma., which, while slightly above the maker's rating for the RK20, is quite safe, and allows 100 to 120 watts of r.f. power output to be had from a single tube, or 25 watts of phone carrier power, running up to 100 watts or more on 100% modulation peaks.

The modulator is nothing more than a simple three-stage audio amplifier having its power supply mounted in the same unit. It employs one 53 (dual high-mu triode)

in two stages of resistance-coupled amplification, developing a voltage gain of over 700. This two stage amplifier operates out of one of the new Astatic crystal microphones (or out of a carbon or other microphone upon addition of a mike-to-grid transformer). The resistance amplifier then feeds a 2A5 pentode developing 3 watts of undistorted output, which is applied to the suppressor grid through a suitable coupling transformer incorporated in the amplifier. The modulator has input and output terminals, a volume or gain control, an on-off switch, and a tone control. The latter is supplied in order to attenuate the modulator's excellent high frequency response in the event that the proposed regulation limiting amateur phones to 3000-cycle modulation bands goes into effect.

The gain and power output of the modulator is more than sufficient to modulate the RK20; in fact, the gain control must be turned down to the point of no antenna or plate current kick during modulation to prevent over-modulation. The frequency response is flat to 4 db. from 40 to 8000 cycles—response which would be considered perfect in a modern high fidelity broadcast station.

Such then, is a crystal controlled amateur phone and c.w. transmitter

for operation in, or quick change to, the 10-, 20-, 40-, 80- and 160-meter bands, capable of 100 to 120 watts power output, with modulation quality equal to the best American broadcast stations. Yet it is available, including everything but antenna and 110 volt power source, at a cost of less than \$1.60 per watt of useful antenna power!

In a future issue will be described a linear amplifier to boost the power to the maximum one kilowatt input allowed, intended for those who doubt the DX ability of 100 watt crystal controlled phone.

Coil Data

L1: 160-meter band, 40 turns No. 14 on $2\frac{1}{2}$ " tube; 80-meter band, 22 turns $\frac{1}{8}$ " copper tubing $2\frac{1}{2}$ " inside diameter, turns spaced equal to tubing diameter; 40- and 20-meter bands, 12 and 5 turns respectively, wound same as for the 80-meter band. Secondary of L1, 6 turns $\frac{1}{8}$ " copper tubing, $2\frac{1}{2}$ " inside diameter, spaced tubing diameter.

L4-L5: $1\frac{1}{2}$ " in diam., length, $2\frac{1}{2}$ ". 160-meter band, 31 turns each No. 13 wire, one on top the other; 80-meter band, 16 turns each, side by side, No. 13; 40- and 20-meter bands, 8 turns each No. 13, side by side.

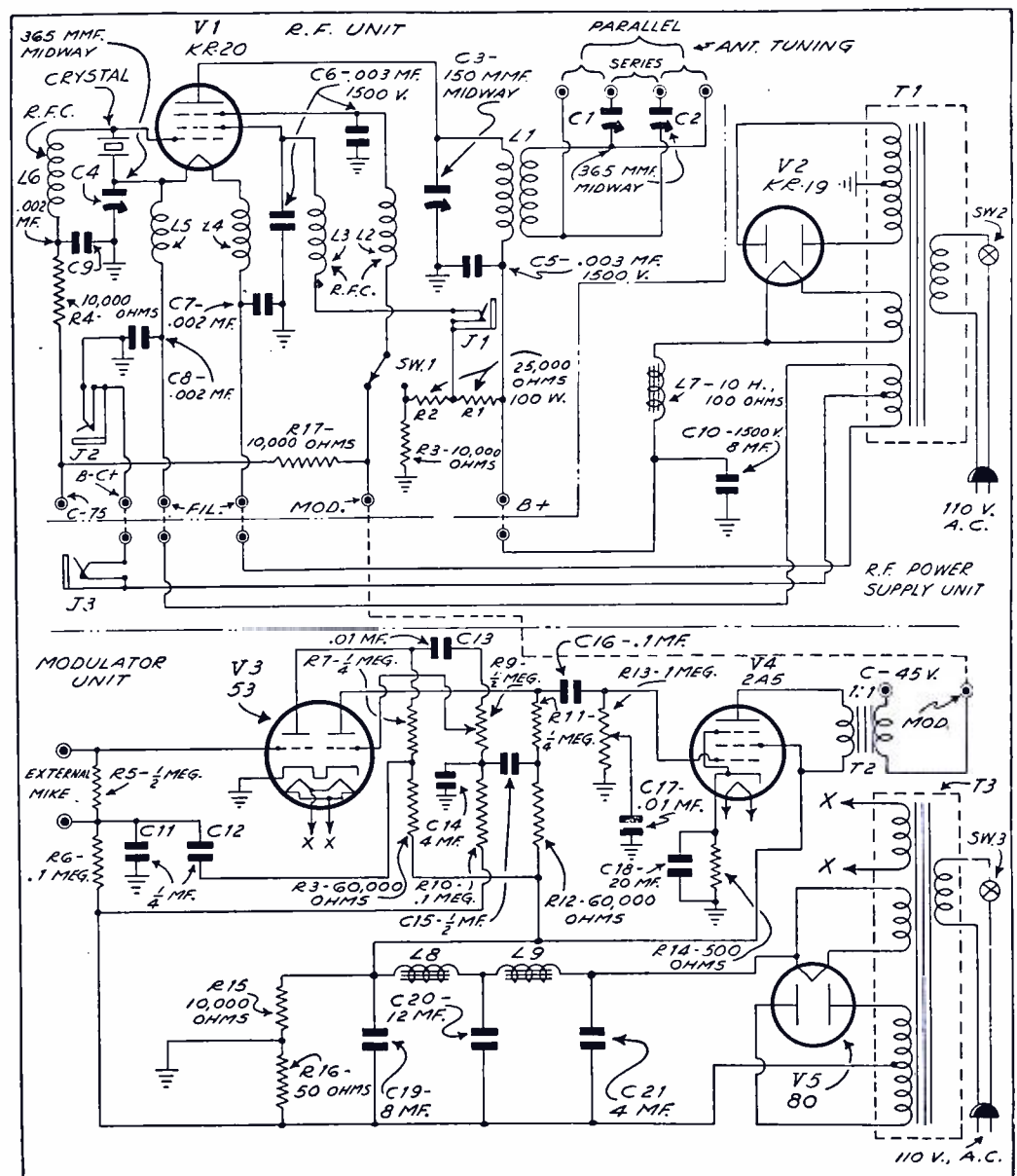

Schematic diagram of the complete transmitter with all values marked.

How to Build and Operate A Simple Two-Tuber

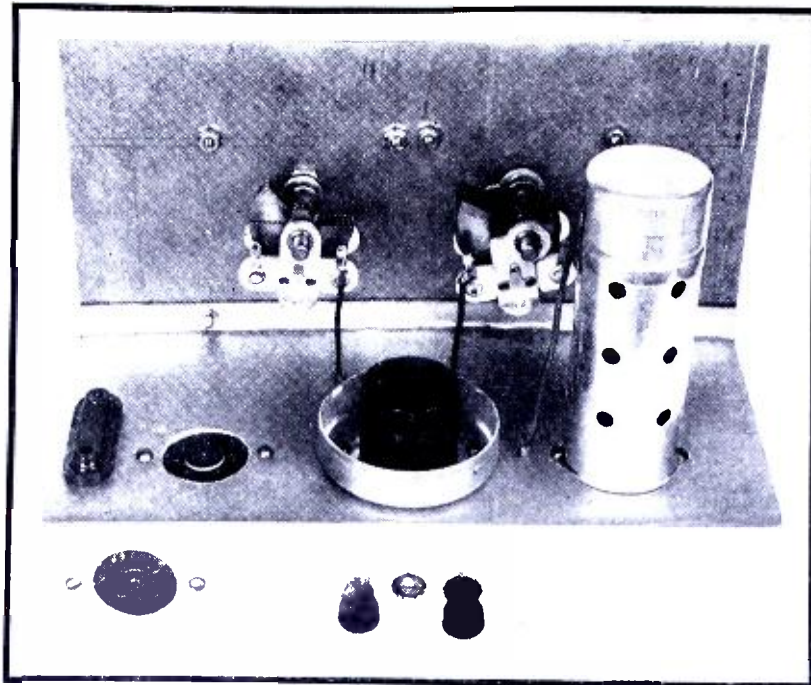

SUMMARY: We make no pretentious claims for this little two-tuber. Its design is perfectly standard in every respect, although it does have band spreading, something not ordinarily found in small sets. Then, too, it may be a.c. operated, an advantage in locations where batteries are considered a nuisance. We recommend this little set to our beginners as a good, stable receiver that will go far toward initiating them into the complexities of short-wave radio. The deck view shown to the left depicts its utter simplicity. Note the small coil.

By S. S. Horwitz *

WHEN we began development in our new radio department, the first thing we had in mind was a short-wave receiver embodying every feature necessary for fool-proof operation under almost every condition. The SCRL-R36 is the receiver which carries out our idea of a really good set. It is what might be termed a "standard" receiver, as we think it has everything that an inexpensive small set should have.

First of all, the regeneration control has been made as smooth as possible. Note the coil data—there are

very few tickler turns. Why? Merely because the 57 tube, which is used, is a splendid oscillator, and when manufactured coils are used, with their correspondingly large ticklers, the tube goes into oscillation with a terrific howl. With the size ticklers used on our coils, however, the regeneration is very smooth, with very little noise until a station is reached, when, of course, the characteristic whistle can be heard.

In these days of crowded channels, something must be done to facilitate separation. We use a very good system of band-spreading in this circuit.

The grid coil is tapped, and to this tap is connected the band-spread condenser. The spreading is such that, on the average, ten points on the main condenser equal one hundred on the band-spread condenser; thus, the band-spread dial is equal to a ten-to-one vernier, which simplifies tuning.

This receiver should prove useful to beginners, as there is nothing "tricky" about it, and should also be an ideal set for those wanting a good receiver for very little monetary outlay. This is one set, when built according to our data, that will not fail to produce splendid all-around results.

In the parts list accompanying this article, there is listed every part needed for its construction. No doubt, many people have some of the parts in their workshop.

In constructing the set, the first thing to do is to drill the necessary holes in the sub-panel. To do that, place the sockets, binding posts and phone jacks on the panel in the arrangement shown in the photograph.

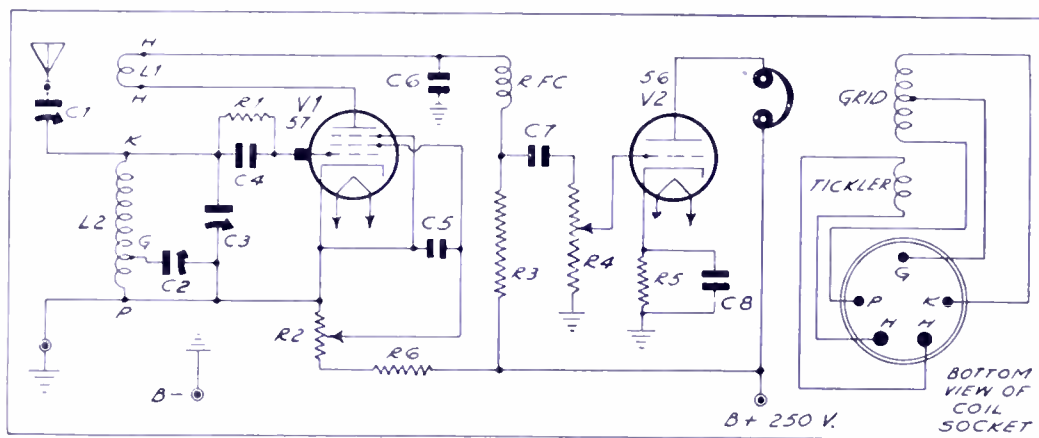

Schematic circuit and list of parts for the two tuber described.

- C1—3 to 35 mmf. antenna tuning condenser (Hammarlund).
- C2—50 mmf. band-spread tuning condenser (Hammarlund).
- C3—100 mmf. tank tuning condenser (Hammarlund).
- C4—.0001 mf. mica fixed condenser (Aerovox).
- C5—1 mf. Sprague electrolytic condenser.
- C6—.0005 mf. mica fixed condenser (Aerovox).
- C7—.02 mf. paper condenser (Sprague).
- C8—10 mf., 50 volt Sprague electrolytic condenser.
- R1—4 megohm resistor (IRC).
- R2—50,000 ohm regeneration control (Electrad).
- R3—250,000 ohm resistor (IRC).
- R4—1 megohm volume control (Electrad).
- R5—2000 ohm, 1 watt resistor (IRC).
- R6—25,000 ohm resistor (IRC).

- RFC—2.2 mh. r.f. choke (Hammarlund).
- L1 and L2—specially wound coils—see text for details.
- V1—57 tube.
- V2—56 tube.
- 2—7 x 10 electralay panels.
- 1—tube shield.
- 1—6-prong wafer socket (ICA).
- 1—5-prong wafer socket (ICA).
- 1—5-prong Isolantite socket (Hammarlund).
- 1—4-prong wafer socket (ICA).
- 2—binding posts, antenna and ground.
- 1—double phone jack assembly.
- 4—coil forms, 5-prong (ICA).
- 1—spool No. 28 Belden wire.
- 2—vernier dials (ICA).
- 2—knobs.
- 1—grid clip (ICA).
- 1—coil shield (ICA).
- 1 pr. headphones (Trimm or Acme).
- screws, nuts, lugs, etc.

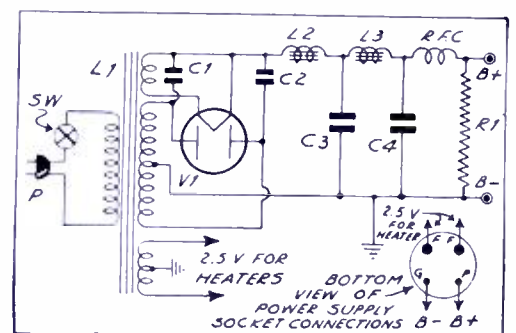

POWER SUPPLY

- C1 and C2—.001 mf. mica fixed condensers (Aerovox).
- C3 and C4—8 mf. electrolytic condensers (Sprague).
- L1—power transformer, with secondary voltages of 5 volts, 2.5 volts and 650 volts center tapped (Kenyon).
- L2 and L3—filter chokes, 30 henry (Kenyon).
- RFC—2.5 mh. r.f. choke (Hammarlund).
- R1—25,000 ohm, 50 watt bleeder resistance (Electrad).
- V1—30 tube.
- SW—switch (ICA).
- P—110 V. plug.

COIL DATA

Coil No.	Grid Turns	Band-Spread Tap (from P)	Tickler Turns
No. 1 (20 m.)	6½, spaced 1-16" between turns	2¼	2¾ close-wound
No. 2 (40 m.)	9½ close-wound	3¼	3¾ close-wound
No. 3 (80 m.)	21½ close-wound	10¼	6¾ close-wound
No. 4 (160 m.)	50½ close-wound	29¼	11¾ close-wound

No. 28 Beldenamel wire used for all windings.

Tickler to be 1-8" to 3-16" from grid coil, *not less*. Experiment until proper distance is found for best regeneration without howling.

Mark the holes to be drilled, remembering that 1½-inch holes must be drilled for the wafer sockets, and a 1½-inch hole for the isolantite coil socket. Also, the hole for the antenna binding post must be made large enough to pass a piece of spaghetti tubing, which should be used to insulate the binding post from the sub-panel.

After the holes are drilled, the sub-panel should be bent in the shape shown clearly in the photograph. The dimensions of the sub-panel when bent should be ten inches long, 4½ inches wide and 2 inches high. The extra half inch is used as a flap to which the panel is fastened.

Next, the panel should be drilled for the dials, knobs and connecting screws. When drilled, mount the condensers and potentiometers, fast-

en the dials and knobs, and join the panel to the sub-panel.

The four sockets should be mounted next; the six prong for the 57, the five prong for the 56, the four prong for the power supply connections, and the five prong isolantite for the coils. The isolantite socket should be used for the coils because of the ease with which it permits the insertion and removal of the coils.

Only one thing need be said concerning the placement of the various small parts: place them nearest the part they are to join.

The coils, being of a special design, must be "home-made." Tube bases or the regulation coil forms can be used. The data is the same for both types.

There is nothing difficult about getting stations with this receiver.

Merely turn the regeneration knob slowly until a bit of static can be heard. The familiar hissing sound is not present in this receiver, so that the ear must be trained to detect when the tube is regenerating. Be sure that the volume control is all the way up, otherwise the signal may not come through. When the tube is regenerating, turn the main tuning dial (the one connected to the 100 mmf. condenser) until the band wanted is located, then the band-spread dial should be used for full band coverage. In getting a station, locate the station by the carrier whistle. If the station is a phone station, tune to center of the whistle; if the signal is strong enough, turn the regeneration down until the whistle just disappears. If the phone station is weak, tune to the center of the whistle and keep the regeneration control at the point of maximum volume. For receiving signals, keep the tube oscillating so as to produce a beat note. The volume control, of course, should be used if the station is unbearably loud.

We have reproduced the circuit of the power supply we use in our laboratories. It is practically humless, and produces a very well regulated output. The 57 and 56 are a.c. tubes, of course, but it is possible to use a 77 and a 34 in the same circuit for a battery-operated set. The secondary turns will remain constant.

Book Review

EARTH, RADIO AND THE STARS, by Harlan T. Stetson, published by the Whittlesey House, McGraw-Hill Book Company, Inc., New York, N. Y., 6 by 8 inches; 336 pages, illustrated. Price \$3.00.

The constantly increasing quest for distant and still more distant radio reception on the short waves has made it necessary for the DX hunter to resort to a study of such seemingly unrelated subjects as geography, chronology, topography and even meteorology. All these factors affect radio reception in one way or another, and listeners who have taken the trouble to acquaint themselves with these highly interesting subjects have found it decidedly to their advantage in logging foreign stations. Thus, if all the phenomena by which electromagnetic radiations are influenced could be taken into account, it would be possible to predetermine the exact hours for best reception in any given locality.

Unfortunately, present-day knowledge has not as yet advanced to the stage where it can make such accurate and precise forecasts, although much good work has already been done. At the present time, scientists are directing their investigations toward the heavens; in doing so, they have opened an entirely new field of astronomy—the study of the cosmic environment of the earth.

Results of experiments along these lines definitely point to the conclusion that the celestial bodies which surround the planet on which we live have a very great influence upon the medium in which radio waves are transmitted. Their effects are manifested in a great many different ways.

In the book, *Earth, Radio and the Stars*, the author has attempted to correlate these varied effects and factors into a simple and concise volume.

The book is well written and should prove interesting to students of astronomy as well as to those who are unfamiliar with cosmic phenomena. It contains interesting illustrations and graphs which represent the result of actual tests and observations carried out under the auspices of the astronomical observatories at Harvard and Yale Universities. Some of the topics discussed are the effects of the moon, the sun, sun spots, solar eclipses, meteors, the stars, and cosmic rays upon radio reception. A chapter on the Sun and the Ionized Layer deals with the highly important Kennelly-Heaviside layer and explains many of the reasons for its strange behavior.

The amount of literature on this subject has been far too inadequate and this book is a fine step in the right direction; it should make a worthwhile addition to the shelf of

every radio listener.—L.O.F.

APPLIED ACOUSTICS, by Harry F. Olson and Frank Massa, published by P. Blakiston's Son & Co., Inc., Philadelphia, Pa., 6 x 9 inches, 430 pages, illustrated.

It is superfluous to say that few, if any, really practical books on the science of applied acoustics have appeared during the past few years. True, such classical works as Sabine's *Collected Papers*, Fletcher's *Speech and Hearing* and Rayleigh's *Dynamical Theory of Sound* will always remain fundamental reference works, but there is need for a text that gives, concisely and authoritatively, the modern practical methods of acoustic measurements—the subject matter of *Applied Acoustics*.

The book starts with the fundamental equations and definitions used in acoustical work.

This is followed by chapters on the commonly used types of dynamical systems—electrical, mechanical, and acoustical—fundamental acoustical measurements, apparatus for the acoustical laboratory, telephone receivers, loudspeakers, testing telephone receivers and loudspeakers, measurements upon dynamical systems, architectural acoustics, measurement of noise, and physiological acoustics.—L. M.

The "All Star"

an all-wave receiver

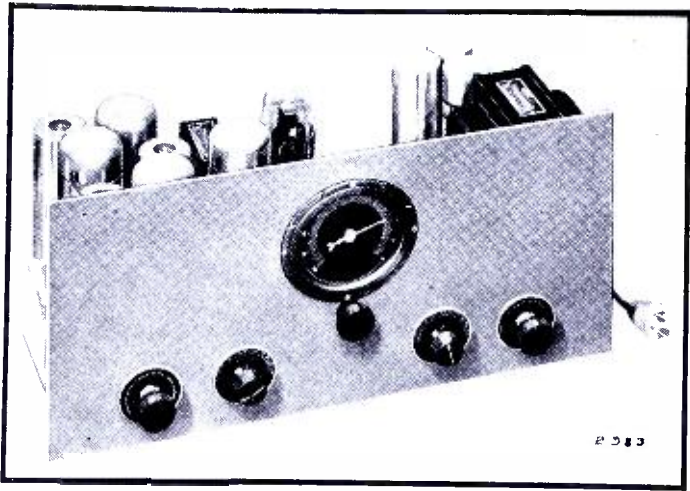

Panel view of the receiver showing the controls.

SUMMARY: A description of a six-tube receiver of the superheterodyne type, the kit for which may be obtained from a large number of dealers and which is designed for home construction. Chassis and panel come drilled and punched. All transformers are pre-set, obviating the necessity for detailed test and adjustment after the mechanical work has been finished. It has good quality and sensitivity.

It is not often that a group of well-known manufacturers get together and decide to put out a receiver that may be constructed at home by the average man—a receiver that has been tested time and time again by those that know how to test. Neither is it often that a receiver so sponsored is really good—good enough to maintain the reputation of the sponsors.

First of all, the All Star is designed to cover, with sufficient overlap, all the much used bands from about 10 to 550 meters (30,000 to 550 kc). Second, it uses plug-in coils, is a superheterodyne, and is well designed. The photographs and schematic circuit tell the story; it will be sufficient for us to merely point out its salient features.

The Schematic Circuit

It is a six-tube set using a 2A7 as a combination mixer and first detector, two stages of i.f. using 58's, a 56 second detector, a 2A5 output tube, and an 80 rectifier. The photograph of the panel depicts the external layout. Looking at the knobs from left to right, they are as follows: volume control, oscillator "tank" condenser, detector "tank" condenser, and on-off switch and tone control.

As shown by the schematic circuit, the volume control is in the cathode leads of the two i.f. tubes; turning it to the right merely decreases the bias on these tubes. The oscillator "tank" condenser is the main oscillator tuning condenser. It is calibrated from 1 to 100, and its setting determines the section of the band over which the main tuning control (the knob which operates the main dial) band spreads. The detector "tank" condenser is also calibrated from 1 to 100 and is tuned to resonance with the oscillator tank before the main, band-spread dial is rotated. The use of the on-off switch and tone control need no comment.

To operate the receiver, it is only necessary to connect the speaker, aerial and ground (the aerial may be a single wire or doublet) and plug into an a.c. outlet. The oscillator tank is set for a particular band, the detector tank is tuned to resonance (turned until the loudest "rush" is

heard) and the band-spread dial rotated until a station is heard. Of course, the proper coils must be inserted in the sockets. Three sets of coils are used to cover the "real" short-wave band: the first from about 10 to 24 meters, the second from about 20 to 45 meters, and the third from about 40 to 100 meters; additional coils are required to tune from 100 to 550 meters. However, the coils are available—coils that are designed specifically for this receiver.

The view showing the deck of the set illustrates the layout quite well. The power transformer is on the extreme left, and the rectifier tube is directly in front of it. To the right of the rectifier are the three filter condensers arranged in the form of a triangle. Immediately to their right are the two coils, the oscillator coil near the panel and the detector coil nearest the front. They cannot be interchanged since one has a four and the other a five-prong socket. The main tuning dial and output tube are next in line. To the right of the output tube is the audio transformer, and to its right, the 56 detector tube.

The cluster of metal cylinders to the extreme right are the i.f. transformer and i.f. tubes. In this cluster, the left can nearest the panel is the first i.f. tube; to its right, the first i.f. transformer. In the center row, on the left, is the second i.f. transformer; to its right, the second i.f. tube. The row nearest the rear contains the third i.f. transformer and 56 second detector previously mentioned.

A 10-inch dynamic speaker is recommended. The set really has quite a bit of volume, which, in this as

well as in any other receiver, can only be appreciated when the speaker can deliver it without distortion. Any dynamic can be used, the only requirements that must be met are that it must have an output transformer designed for use with a 2A5 and it must have a 2500-ohm field coil. These specifications are standard.

A feature of the receiver is that no adjustments are required after it is mounted and wired. All the coils have been adjusted at the factory and the i.f. transformers are pre-set. There is no need to borrow oscillators and output meters upon completion of the mechanical work. Everything has been done for you.

The bottom view of the set is very enlightening. No messy wires, misplaced parts, or dangling resistors. Everything has its place. The wiring is simple, and can be completed in a few hours.

Getting Started

If you like the receiver and are thinking of building it, there are definite steps to follow. Go to your nearest dealer and ask him for the foundation kit of parts for the All Star all-wave receiver. This includes a drilled and punched metal base and panel for the set. Next, ask for the special blueprint and four-page descriptive folder which also includes a large size pictorial diagram, a complete list of parts, complete instructions for assembly, instructions for wiring, and instructions for final adjustments and tuning. There is no charge for this data. The sponsors of this receiver have arranged for nationwide distribution, and no diffi-

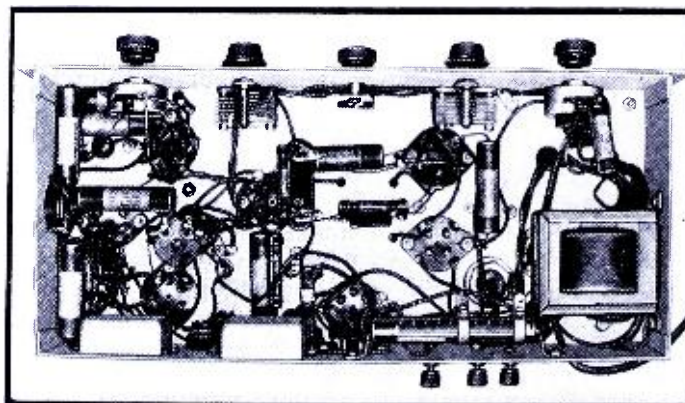

Bottom view of the receiver showing the neat placement of the small parts and the simplicity of the wiring. Every small part has its place, eliminating the usual dangling resistors and condensers, which always have a habit of falling off.

culty should be experienced in obtaining these folders. If in doubt, write to SHORT WAVE RADIO directly, and we will be glad to forward them to you.

A word about results. Your technical director took the receiver home for a few days and twirled the dials. Operation was phenomenally simple. You just set the tank condensers and tune the main dial, which has a six-to-one ratio. After a little experience with the set, it is an easy matter to know just where to set the tank condensers for proper band spreading.

Band spreading, you know, is not the same over all settings of the tank control. At maximum tank settings (100 on the dials) the spread is good; on minimum settings (near zero) band spreading is not so good. With a little experience, however, it is a simple matter to know just where to set the tanks for best spread.

The tone control is a mighty useful thing. The inherent superheterodyne hiss and external noises may be decreased appreciably by means of the tone control. Also, because of the variable- μ tubes, there is no need to worry about cross talk as the volume control is varied.

The usual run of foreign stations were tuned in with ease. After a while, the tanks were set for the amateur band and many "ham" phones were brought in on the speaker. The usual run of short-wave receivers are band spread only on the broadcast sections, and, therefore, are quite useless for amateur phones. But when the set has continuous band spreading, it is surprising how many more stations can be pulled in when adjusted for the "ham" bands.

Antenna facilities are more than sufficient. Either a doublet or single

Deck view of the receiver. Here are the parts atop the chassis. The coils are shielded and the r.f. and audio units are spaced sufficiently to prevent fringe howling. The speaker plugs in from the rear by means of the conventional socket.

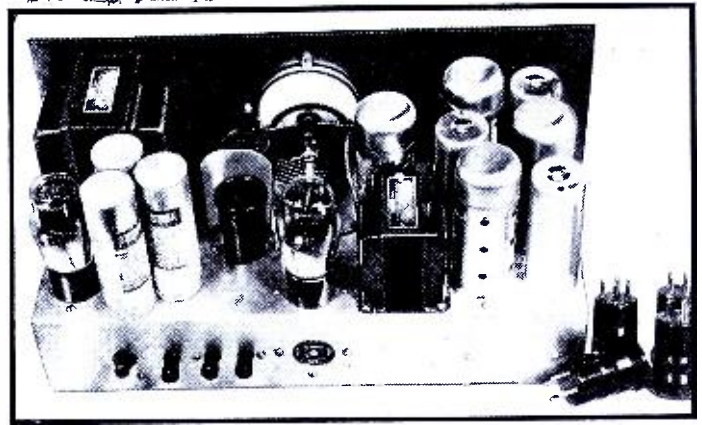

wire affair may be used, with or without a ground. If a single wire aerial and a ground is available, connect them to the two outside posts (be sure the aerial goes on the correct one) and ground the center one; if a doublet is used, connect to the posts that are closest together, as shown on the schematic circuit; a ground may or may not be required.

Some people have difficulty calibrating a continuous band-spread receiver. This is true only because sufficient care is not taken in the logging of the tank settings. These knobs are small, and, therefore, the operator has a tendency to read them inaccurately, not because they are small, but because he feels that they are relatively unimportant. The two tank settings are extremely sharp—far sharper than the main dial. Be sure to read them carefully, especially if you want to find the same station in the same place all the time.

Don't be fooled by the apparent broadness of the band-spread dial. Even though your tuning condenser may be of the 180° type, the dial covers 270°, which further broadens the band spreading. You can't have too much spread on some sections, like the 49-meter band.

Quietness of operation is always a virtue, that is, freedom from hum, since noises are usually beyond the control of the operator. A slight amount of hum does not show up on strong signals at all; but on the weak ones, where every db counts, it is essential that there be as little hum as possible. There is a good technical reason for this. On weak signals, the detector—regardless of its type—is a square law detector, and a property of square-law detectors is that its output is proportional to the product of the desired signal and any other undesired signal—hum in our case. The louder either one becomes, the louder *both* become. With little hum, and a slightly stronger signal, the output will increase faster with increasing signal than with increasing hum, and the reverse is true if the hum is louder than the signal. Result—an unreadable signal.

When the signal is very large, and the detector becomes linear, its output is independent of the strength of the smaller signal—hum in our case—so that it is not noticeable. The hum level in the All Star is lower than usual, as can be expected after examining the filter used.

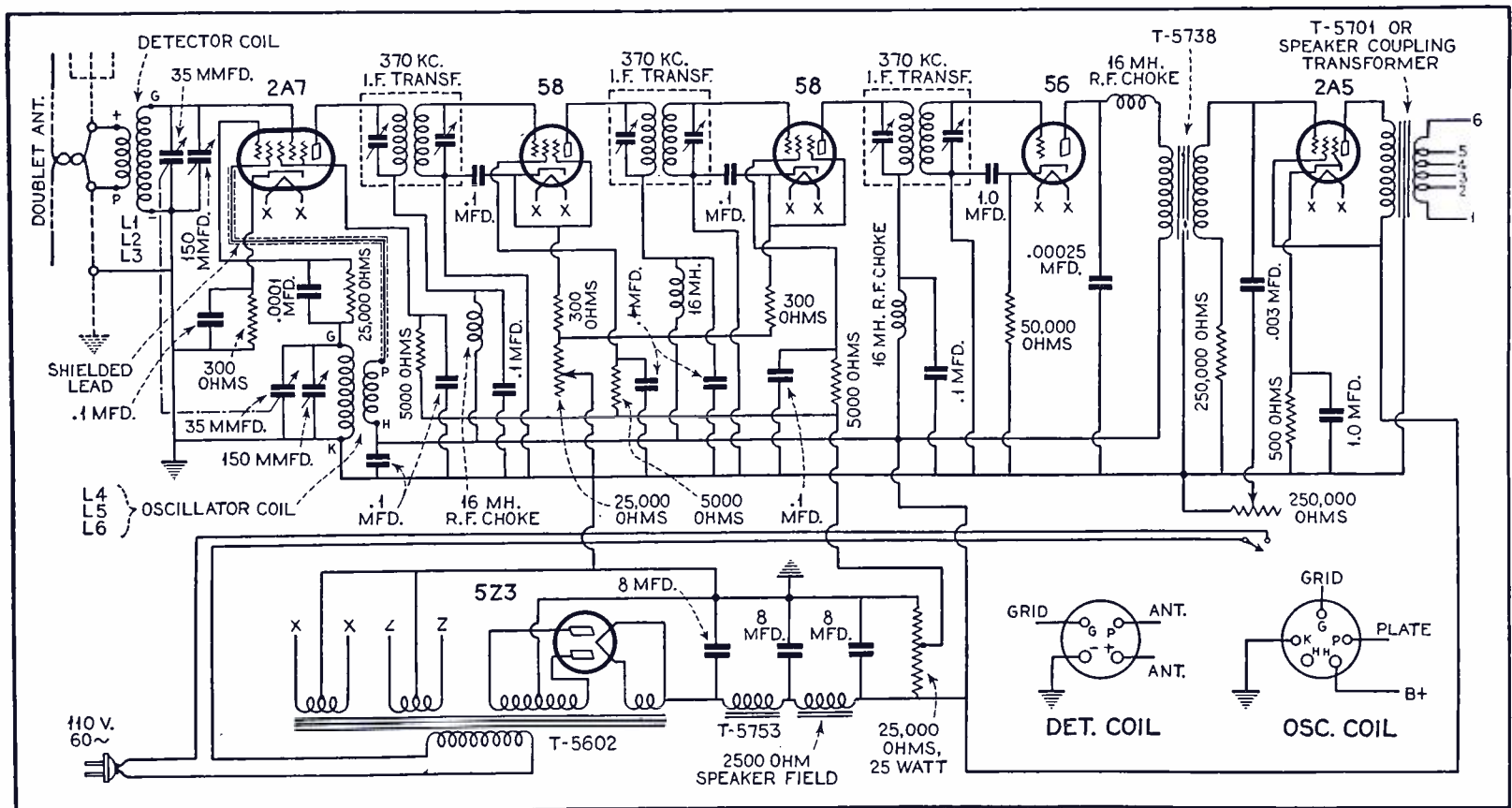

Schematic circuit of the receiver with all values marked for convenience.

Putting the 12A7 to Work

SUMMARY: *The characteristics of this tube were given in the September issue of this magazine; we present here a working example of its use. This tube is a combination power rectifier and pentode in a single glass envelope; as such, it can be incorporated in a simple, single-tube, a.c.-d.c. receiver. We would appreciate hearing from anyone constructing this little set, letting us know of his results.*

By T. C. Van Alstyne

THE short-wave builder, particularly if he delights in ultra-midget construction, will welcome the new 12A7 tube (the number 12 stands for the heater voltage; A, for amplifier; 7, the number of base contacts). Containing as it does a half-wave rectifier and a pentode in one small glass envelope identical in size to the familiar 58, it suggests the ultimate in compactness and portability, making possible a one-tube all-electric a.c.-d.c. receiver. Separate connections to the units are brought out to the small seven-pin base, adding versatility to its other features.

Two six-volt, 3 ampere heaters are connected in series internally: one is for the rectifier, the other for the pentode. When the units are segregated for discussion, there is nothing difficult to understand about the 12A7. The rectifier portion, as previously suggested, is of the heater-cathode type. That is, cathode 4 in the diagram is heated by the electrically isolated heater 1. When the a.c. line voltage is applied to the rectifier plate 5, the positive halves of the cycle pass over the electron stream to the cathode, thus delivering a pulsating d.c. to supply the plate of the pentode section. When the positive side of a d.c. source of supply is applied to the plate of the rectifier, a continuous d.c. output is acquired.

The pentode section contains the same elements as any other pentode: the heater 7, the cathode 6, the screen 3, the suppressor, connected to the cathode internally, and the plate 2. The cathode emits electrons which are attracted to the positively charged plate, the screen clears the electron cloud around the cathode by accelerating it to the plate, and the suppressor prevents secondary emission from the plate. The manufacturers' ratings are as follows:

Pentode Section

Plate volts	135
Screen volts	135
Control grid volts	13.5
Plate current	9 ma.
Screen-grid current	2.5 ma.
Amplification factor	100
Plate impedance	102,000 ohms
Mutual conductance	975 micromhos

Rectifier Section

Plate volts	135
Plate current	30 ma.
Max. output	4 watts

While this is not a constructional article, it could not be complete without a description of the circuit for the 12A7's use; the necessary information will be found in the accompanying circuit diagram. It is particularly important that the 350-ohm resistor, R5, be exactly of that resistance and of 50 watts capacity, as this is a dropping device to reduce the line voltage to the 12 volts required for the heaters. Too low a resistance at this point will result in the tube burning out, while too high a resistance will render the set inoperative. It should be isolated as far as possible from the other components, as considerable heat will be developed. A filter choke taken from an old B eliminator will prove excellent for L4. The filter condensers C7 and C8 should be of the double 8 electrolytic type; the can is the com-

mon negative connection, grounded. The number of turns for the tuning inductances L1 and L2 will necessarily depend on the wavelengths to which the builder wishes to tune. Both inductances must be wound in the same direction on the same form about 3/4" apart. The following will serve as a guide to what will be required using a 150 mmf. (.00015 mf.) tuning condenser in the position C1 and coil forms having a 1 1/2" diameter:

Meters	L1 Turns	L2 Turns
200-100	45 No. 28	15 No. 28
100- 50	20 No. 28	10 No. 28
50- 30	8 No. 24	6 No. 28
30- 15	4 No. 18	5 No. 24

The antenna series condenser C2 should be of the variable fixed type, having a capacity of 35 mmf. An aligning condenser such as used on broadcast receivers will be found satisfactory. The ground series condenser, C3, should be of about the same capacity, its being finally determined by experiment. R3 is the regeneration control operated in the usual manner.

When a d.c. source of power supply is used, the attachment plug must be inserted in the outlet so that the positive side of the line will be connected to the plate of the rectifier section of the 12A7, otherwise the receiver will not function. If metal is used for chassis construction, care must be taken to see that no connections are allowed to touch it.

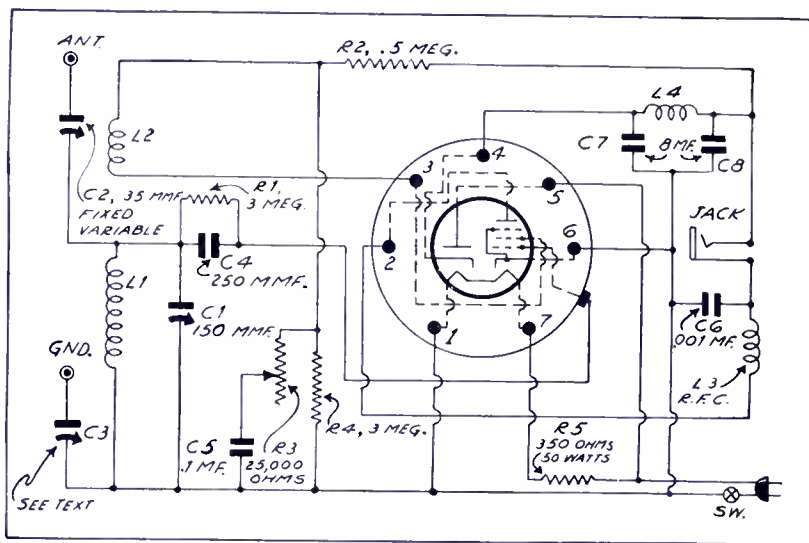

Schematic circuit of the one-tube a.c.-d.c. receiver. The "two tubes" are in a single glass envelope and combine to make an efficient little set. The coil used in the antenna circuit is a standard secondary of an ordinary short-wave coil.

Editorial Note

Some years ago—two, to be exact—your technical director wrote a letter to a large tube manufacturer suggesting a tube structure which would incorporate an output and power rectifier in one envelope. He was advised at the time that such a combination had no real merit and that there were already too many tube types now on the market and that the aim should be to reduce, rather than increase, the number of different types of tubes.

Nothing was done about the matter in view of the nature of the reply, and it is with considerable satisfaction that he notes the appearance of the 12A7.

Right now he wants to push the announcement of another small group of tubes that have a real market—a market analogous to the 6.3-volt series.

There is need for a brand new 2-volt series, similar in construction to the 6.3-volt series. Such a series would have use in portable sets and in receivers intended for rural use.

Such a series was supposed to have been announced a year ago, according to a reliable source. No sign yet. Like television, it seems to be hiding around a corner, awaiting the arrival of some mysteriously opportune time.

—L. M.

Some Notes on Amateur Licenses

A Brief Survey of the Amateur License Situation, Intended for Beginners

JUDGING from our ever increasing mail and the sale of the booklets entitled, "How to Become a Radio Amateur" and "The Radio Amateur's License Manual," many of our readers are becoming interested in amateur radio from the transmitting standpoint. They hear hundreds of amateur phones on the air and eventually they get bitten by the bug themselves.

The letters we receive indicate that considerable misunderstanding exists about transmitting procedure in general. We will attempt to answer the most commonly asked questions and to straighten out a lot of queer notions that many radio experimenters seem to harbor in their minds.

License Required

First of all, it must be clearly understood that a license issued by the federal government is needed for the operation of an amateur station, regardless of its size or location. This costs the applicant absolutely nothing, but it involves a written examination on radio theory and operating and a 10-word-per-minute code test. The code test is given first and the theoretical exam afterward if the applicant passes it successfully.

Even if you intend to operate with phone exclusively, you *must* know the code in order to get a license. At first sight this appears to be a rather unnecessary and unfair requirement, but there are some very good reasons for it, based on twenty-two years of recognized amateur-radio experience. Dots and dashes are the real language of radio; phone transmission is relatively unimportant, and phone stations are terrifically hoggish insofar as space in the ether is concerned. A single phone station takes up as much room on the air as ten telegraph stations and doesn't carry as far as a telegraph transmitter of equal power.

The available amateur phone channels are already so hopelessly crowded that unrestricted amateur phone operation would make communication utterly impossible—which it almost is already in certain bands.

Code Not So Difficult

As a matter of fact, the code part of the test is not nearly as formidable as most people think. The idea of the code test is more to prove the earnestness of the license applicant than his immediate ability as an operator. The code acts as a deterrent to a lot of irresponsible, selfish persons who have the money to spend for expensive transmitting apparatus but who are too lazy to earn their right to be on the air.

Just how difficult the license examination is may be determined from the fact that 10-, 12- and 14-year old boys and girls, as well as 70 year old patriarchs, go through it with high marks!

The frantic bellowing of certain "friends of the phone amateur" notwithstanding, it is exceedingly unlikely that the code test will be dropped in the near future, even for restricted work on the very high frequencies. The general attitude in government—and even some amateur—circles is that the amateur examination is altogether too *easy*, not too difficult!

Don't get the idea that the government is against amateur radio. Quite the contrary! The marvelous pioneer work done by "hams" in high-frequency communication is officially recognized in Washington, and the United States Government always defends its amateurs against the really ferocious attempts of other governments of the world to slice up the amateur frequency bands for their own use—which are usually military in nature.

Three Classes of Licenses

There are three classes of amateur licenses. To be eligible for Class A, which carries with it unlimited privileges in *all* the assigned bands (both phone and telegraph), the applicant must have been a licensed amateur for at least one year and must personally appear before government examiners and take a special test dealing with both telephone and telegraph apparatus.

The requirements for Class B are simpler; no previous experience of any kind is necessary, and the written examination is less extensive, but the applicant must still appear personally for the code test. Class B carries unlimited telegraph privileges and restricted phone privileges. Since this is the kind of license most amateurs start with, it is important to note that the "phone privileges" referred to are available only in the 1800-2000 kc. ("160 meter"), 28,000-28,500 kc. ("10 meter"), 56,000-60,000 kc. ("5 meter") and 400,000-401,000 kc. (" $\frac{3}{4}$ meter") bands. Class A operators may use phone in all of these bands and also in the "20" and "75" meter bands. In other words, you start your phone experience on either the very short or very long parts of the bands and work inward.

The third kind of license, Class C, has been devised for the benefit of people living more than 125 miles from Washington, D. C., a radio district office of the Federal Communications Commission, or a city in which periodic examinations are held. An applicant for this grade

must have his application signed in the presence of a notary public by a licensed radio telegraph operator holding an amateur Class B license or any of the higher amateur or commercial grades, or by the operator of an official government station. This last provision is recent, and applies particularly to outlying military or naval posts where they are Army or Navy operators (who need no license) but no amateurs.

There are twenty permanent district offices of the FCC. In making application or sending letters of inquiry, be sure you pick the correct office for your particular location. The whole list of offices, with the states and counties they serve, is too long to be printed here, but it can be found in "The Radio Amateur's License Manual" previously mentioned.

Single Card Issued

Formerly separate station and operator's licenses were issued. Now a single small card combines them both. An applicant who passes the examinations is ready to go on the air the minute his license comes through, as it will also show his official call letters.

Taking a few other frequently asked questions at random,—

Amateur licenses are issued only to citizens of the United States, but there are no limitations as to age or sex. Quite a few girls and women are active "hams."

Portable stations of the 5-meter "transceiver" type very definitely come under the law, and must be operated only by licensed persons. Don't let anyone tell you differently!

Amateur licenses cannot be issued to corporations, associations or other organizations, except in the case of bona fide amateur clubs; even then, the station license is made out in the name of a licensed amateur operator as trustee. The reason for the restriction against business firms is plain. If a corporation with scattered offices could erect stations under amateur calls and on amateur frequencies they would jam the air with commercial messages that properly belong on regular telegraph, telephone or commercial radio circuits.

No Commercial Messages

Amateur stations must not be used for transmitting messages for pay, either direct or indirect, or for the broadcasting of any form of entertainment.

Amateurs may experiment with television, facsimile or picture transmission in the 1715-2000 kc. and 56,000-60,000 kc. bands. This is not generally known.

Amateurs may operate 56,000 kc. and 110 megacycle portable-mobile
(Continued on page 43)

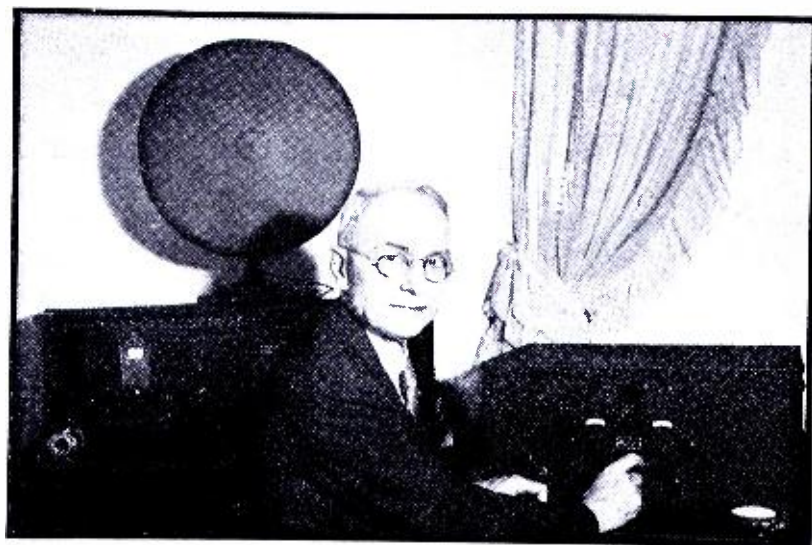

Foreign Station Department

Conducted By J. B. L. Hinds

Photograph of J. B. L. Hinds in a characteristic pose just before tuning in for some rare ones.

SINCE my connection with SHORT WAVE RADIO as Conductor of the Foreign Station Department, repeated requests have been made to listeners and readers to send in reports of reception, letters of information, questions pertaining to any station, or requests for any information desired in connection with this Department. I am very happy to announce that many letters are being received daily, which are being answered promptly and directly. These letters come from all parts of this Continent and even from across the seas, and my hearty thanks are extended to all for their kind words and best wishes and their letters of helpfulness.

Many Letters Received

Among the many are letters from Carl Goulet, Dalhousie, in the northern part of the province of New Brunswick, right where the Restigouche River empties into the Bay of Chaleur; Wm. Bremer, Kings Park, L. I.; Robert Wheatley, Denver, Colo.; H. J. Dollard, Lynn, Mass.; Wilmer A. Rowen, Dallas, Tex.; Franklin Heathco, Indianapolis, Ind.; Bruce T. McCoun, Quoge, L. I.; H. L. Kent, Jr., Stillwater, Okla.; Chas. Parish Jr., St. Louis, Mo.; H. H. Kingston, Rochester, N. Y.; W. C. Motz, Amherst, W. V.; Alfred W. Mann, Middlebrough-on-Tees, England; R. Lee Williams, Clarksburg, W. Va.; Margaret Lynn Hamilton, a real dyed-in-the-wool lady DXer; Roger Legge, Jr., Binghamton, N. Y.; Cav. Marco A. Pizati, New Orleans, La.; William Sinclair, Warder, B. C., Canada; and John H. Watrous, San Mateo, Calif.

The impressive lists of stations received from these writers, located in all parts of the Continent, prove conclusively that the short-wave receivers of today are receiving the programs of the world regularly and that real short-wave DX is here to stay. It is surprising to note from this list that the European stations are being heard regularly and consistently on the west coast of the United States and in Canada. The letter of Alfred W. Mann, of England, is particularly interesting as

regards United States stations heard in England, and is being reprinted in another column of the Station Department.

In letters received are many requests for addresses of foreign broadcasting stations, information as to how to tune in certain stations, identity of stations heard on particular bands, the best method to tune a band-spread receiver, the procedure to follow in securing verifications to reception, and many others.

While I will discuss these particular subjects in this or subsequent issue of SHORT WAVE RADIO, it is my desire to reply personally to all letters and to assist the readers of this magazine in every way possible so that they may enjoy their receivers to the fullest extent. The only request to be made is that you enclose a self-addressed, stamped envelope where a reply is desired. You may address your letters to J. B. L. Hinds, 85 St. Andrews Place, Yonkers, New York, U. S. A.

Station Lists

You have noticed, no doubt, that we have been running lists of short-wave radio stations and the days and hours they are on the air. We are now adding to this service by showing the complete addresses of the stations shown under the caption "Best Short Wave Stations" which should materially assist you in writing to the stations for verifications, etc.

While on the subject of verifications, and as I stated in a previous

issue, I have always endeavored to secure a verification for each station received. A sample of the printed form I use in giving the details of what I heard to the station heard was printed in August issue of SHORT WAVE RADIO. While working at my receiver, I have a small pad of paper handy and jot down the details of what I heard, showing time each selection is rendered, title of piece sung or played, if able to do so, whether artist is tenor or soprano, if accompanied by orchestra or piano, etc. If you can readily identify the station, thirty minutes of listening time is sufficient, but more may be taken if thought necessary.

Time Wasted?

I admit, however, that quite often I use up several sheets of paper and do not ascertain the station to which I was listening. Possibly I waste that much time if I did not enjoy the program. These reception details are transcribed to the form mentioned, a carbon copy of the form being retained along with the memorandum work sheet. If you expect and desire a reply, you should enclose an International Reply Coupon with same in mailing to the station. These coupons may be purchased for nine cents at any post office, and are exchangeable in the country to which forwarded for postage of that country. It should be appreciated that the majority of foreign stations could not bear for long the added expense of paying postage on an-

Cia. Radiotelegraphica Brasileira	Ilmo. Sr.
Caixa Postal 500 - Rio de Janeiro	Mex
Rio de Janeiro, _____ 193__	J. B. L. Hinds
Prezado Senhor, Dear Sir,	85 St. Andrews Place Yonkers, N.Y., U.S.A.
Agradecemos penhorados a carta de V. S. datada de _____	
We beg to acknowledge receipt and thank you for your letter of May 27 th	
A estação que V. S. declara ter ouvido era a nossa estação de Santa Cruz	
The station which you state to have received was our transmitting Station at	
(Districto Federal), trabalhando em radiotelephonia e usando o transmissor	
Santa Cruz (Federal District) working in radiotelephony and using its short	
" _____ com a frequência _____ kilocycles.	
wave transmitter "YMA" on the frequency _____ kilocycles.	
Resposta May 12 th - 11 th + de	
Verificação	
Atenciosas saudações Yours very truly	
Cia. Radiotelegraphica Brasileira	

Verification from Rio de Janeiro. This card is somewhat unique in that alternate lines of the card are in English and in the native language of Rio de Janeiro, Portuguese. This indicates the number of such cards that must be sent to English-speaking people.

Empresa de Teléfonos Ericsson

DIFUSORA  COMERCIAL

P. O. BOX 1396
México, D. F.

6130 KC'S. **XxETE** 48.94 MTRS.
9600 KC'S. **XxETE** 31.25 MTRS.

TENEMOS MUCHO GUSTO EN VERIFICAR SU REPORTE A NUESTRA TRANSMISION DEL DIA. *9.0. M. M. MANIFIESTANDOLE ESTAR muy agradado por su atencion EN ESE PROGRAMA.*

NOTA: MUCHAS GRACIAS Y 73c. ING. R. S. BRAVO. (Eng in charge)

A very formal-looking veri from XETE, with the call letters of XEAL written between the letters XETE, as shown. There is no mistaking the frequency and wavelength used by this station.

We will choose the 31-meter band for illustration purposes. First, set your oscillation dial (OCS) at 84. Now track your W.L. dial with it. Turn the band-spread dial up to 90 or 91. With the receiver I use, you would receive EAQ, Madrid, Spain. Let EAQ therefore, be your key station for the 31-meter band. It will come in at about 90 on the band-spread dial. Now leave your OCS and WL dials alone and turn down the band-spread dial with the volume control well up. You should receive GCW about 81½, C91AA at 63½, HBL at 63, W3XAU at 62, VK2ME at 59½, VK3LR at 59, GSC at 59, DJA at 57½, GSB at 51, VK3ME at 51, the latter two transmitting on the same wave, 31.55 meters.

Each day, after establishing the key station, see that you start the evening by tuning in EAQ at some point on band-spread dial. This can be done by adjustment of the OCS dial. That is, if you tune in EAQ at 95, adjust the OCS dial slightly to bring the band-spread reading down to 90, or whatever point you decide on using. If this is done each day, you should receive the balance of the stations on the 31-meter band at the same point on the band-spread dial each day—if the stations are on their correct frequencies. Follow the same procedure on the other bands. Any inquiries will be promptly answered by letter if further information is desired.

A Few Letters

Mr. J. B. L. Hinds,
Station Dept., SHORT WAVE RADIO,
New York.

Dear Sir:

The short-wave reception reports which are published in SHORT WAVE RADIO, of which I am a regular reader, greatly interest me. Maybe a report from an Englishman using an American receiver might prove interesting to SHORT WAVE RADIO readers who use the same make of receiver. Incidentally, I shall be pleased to hear from any reader using a Baird 1931-1932 Universal Six, which is the make I use here, built from a complete kit. You are

swers to all the letters received by them. In making your report write legibly. Better still, use a typewriter if possible. Be sure and apply sufficient postage to your letter before mailing. Print your name and address plainly on your letter and on envelope in which forwarded.

I assume that the majority of listeners procure and file verifications; but doubtless there are a great many who do not and have no desire to do so, any more than they would have of making a collection of postage stamps or other sundry articles. This is pretty much a matter of sentiment. Some people have a mania for collecting verifications and will use any means to obtain one to show to their friends; but, as I see it, one would be deluding himself, and I believe that there are not many who would resort to such a practice. I would not like to have within my collection verifications to programs which I knew I did not listen to.

Page Mr. Bouck

I recall reading an excellent article in the *New York Sun* on this self-same subject by Zeh Bouck. In this article, Mr. Bouck said that "he was interested in short-wave reception for several reasons." He went on to name them; they were, in substance, as follows: the check he gets for his column; to copy KUP's press reports in code; to receive really enjoyable European programs in the afternoon and early evenings, as well as Australia at 5.00 A.M.; providing an excuse to get away from the wife, cats, baby, and a noisy refrigerator (his listening post being located in a shack in a hillside two miles from home); and last, his interest in receiving verifications.

I think Mr. Bouck has some very good reasons, and, possibly, named them in order. I was also much impressed with the rest of his article on verifications, as I have many thoughts in common with him on this subject. I am not, however, blessed with a shack two miles from the family and interferences, and must be content to remain in an apartment building occupied by fifty-six families and put up with vacuum cleaners, washing and ray machines, etc., the interference from which carries through the house line. I

must also put up with the stopping, starting, passing and idling automobiles at a location where two busy streets cross on up grades, a street-car line 500 feet from me on one side and power lines in close proximity to my aerial. While I sometimes think that there are fifty-six aeriels on top of the building and that all fifty-six families own automobiles, I manage to derive considerable enjoyment from my short-wave receivers. It has been said that there is a time when "patience ceases to be a virtue," but I have not yet arrived at that time in life. In operating a receiver, one has ample opportunity to learn how much patience he really possesses, and how much ingenuity he can exercise to overcome interference.

As you know, SHORT WAVE RADIO has been publishing letters from short-wave radio stations all over the world in an effort to furnish you with authentic data on their activities. It is the intention to continue to print such information in station department space unless such letters simply give changes in time schedules, in which cases the changes in time will be embodied in the lists of stations.

I have received quite a few letters in regard to my mention of tuning a band spread receiver, and learn that many have purchased, lately, such up-to-date receivers. I assume that those who have been operating them need no instruction; but for the benefit of those who are making inquiries and for those who do not know, I will give an example of how I tune my Comet Pro.

Veri from YV5BMO. This one is written entirely in Spanish, although it is quite easy to translate without a knowledge of that language. Senor Vegas is the owner and director of the station.

Teléfonos: Oficina No. 550 Estudio No. 100 Dirección Telegráfica y Cablegráfica: VEGAS		Dirección : Oficina: Calle Registro Estudio: Las Delicias Apartado de Correos : 214
<p style="text-align: center;">La presente lleva nuestro agradecimiento al Sr. J. B. L. Hinds de Yonkers quien nos ha reportado nuestras trasmisiones de Broadcasting en Ke. 6.070 y esperamos oír nuevamente sus valiosas noticias. Estamos a sus órdenes.</p> <p style="text-align: center;">Maracaibo: 11 de Abril de 1934.</p> <p style="text-align: right;">"ECOS DEL CARIBE" <i>S. Vegas</i></p> <p style="text-align: center;">Propietario y Director: Santiago M. Vegas</p>		

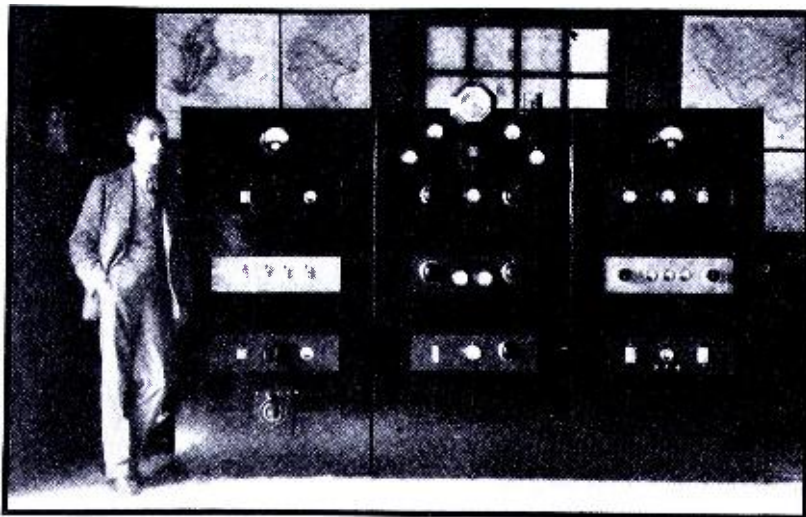

 MANIZALES • COLOMBIA S. A.
 7.142 Kics. 42 mts.

HJ4ABB

Reporte de *J. B. R. Lind's Jonkers*
 Fecha *June 1st 34*
Many thanks Bro for

therefore at liberty to publish my full address.

The following stations are heard very consistently at terrific dynamic speaker volume: LCL, DJC, CT1AA, OXY, I2RO, HVJ, RV59. Amongst other stations heard at volume offering real entertainment value are: PRD3, GSB, W3XAL, W1XAZ, W2XAF, HBL, JVH (at present testing with PHI). JVH is located at Kemakawa Choo Chiba Ken, Japan. I somehow seldom hear VK2ME, although I heard his Empire Day program. J1AA, 19.3 meters, on June 24th came over like a local, with speaker volume.

Early this morning W8XK, 25.27 meters, was heard with terrific volume equal to the local broadcasting stations 70 miles away. Receive many amateurs on the 20-meter band. Other stations received ORK, FYA, CNR. In addition to these, ZSB, around 33 meters, from Cape Town has been heard at R4 on speaker. Various fishing trawler phones, airplanes and other transmissions are heard.

I am sure that the TRF type of receiver is an O.K. proposition if carefully and accurately balanced, but can be pretty dead otherwise.

In conclusion, congratulations on the high technical excellence of SHORT WAVE RADIO and its really useful station lists. Personally, I shall be pleased to see future articles dealing with transmitters for new "hams," also converting TRF's to automatic volume control. Cordial regards and best wishes from

Yours sincerely,
ALFRED W. MANN.

I am quoting below a letter received from Mr. Guy R. Bigbee, 66th Infantry (Light Tanks), Fort Benning, Georgia, which is quite interesting:

"Am assuring you that your magazine is enjoyed and has been a help in logging of foreign stations, as I now have the following nations verified: Norway, Great Britain, Germany, France, Spain, Switzerland, Portugal, Italy, Morocco, Mozambique, Australia, Indo-China, Canada, Mexico, Cuba, Dominican Republic, Puerto Rico, Argentina,

.....

Above: Photograph and veri from HJ4ABB. The handsome gentleman leaning nonchalantly against one of the panels is the proud owner of the station. Right: A good view of the transmitter at RV59, that powerful station from the U. S. S. R., so strong in this country.

.....

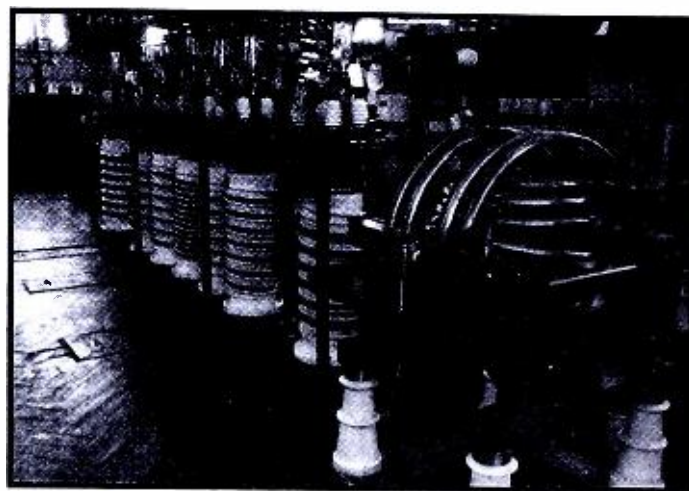

Brazil, Bolivia, Ecuador, Peru, Colombia and Venezuela. I have reports mailed to U. S. S. R., The Vatican, India, Austria, The Irish Free State, and several others in countries already logged. I expect to have several unique verifications by this Fall as many of the stations in Asia, as Japan and India, take too long to verify reports mailed them."

Mr. Bigbee encloses copy of verification from CR7AA Portugese East Africa. It is understood this station transmits on 84.67 meters on Mon-

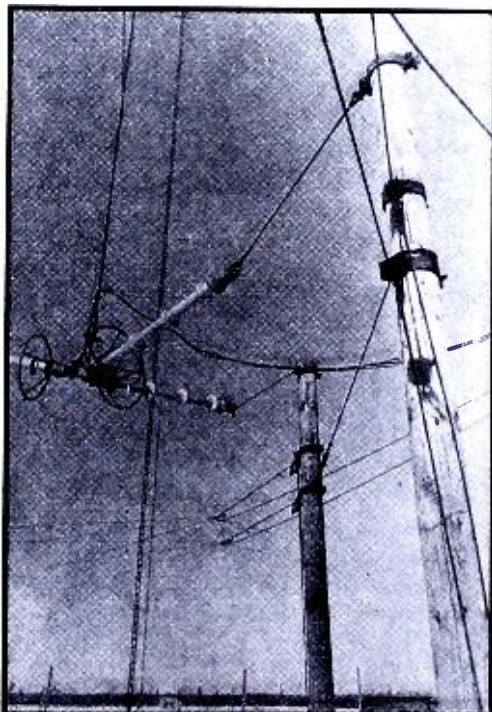

Two of a group of masts used at the U. S. S. R. stations. Not so different from some of our own short-wave stations.

days, Thursdays and Saturdays from 8:30 P.M. to 10:30 P.M. Local Time, which would be 1:30 to 3:30 P.M. Eastern Standard Time.

YV4BSG, Caracas, Venezuela, has changed its call letters to YV4RC. A verification received recently is made up in yellow and red, headed *Estacion "SAR"*.

Japan, through the medium of station JVM, is still coming in every morning into America on 27.93 with a somewhat shaky carrier. The Japs seem to like to talk, and they seem to stick at it each morning until about 6:00 A.M. E.S.T., when they begin their musical programs—about the time I must begin to think about getting ready for work. I have not as yet taken their music very seriously, as I have not really appreciated what music I have heard. It probably takes time to get used to it.

27.93 meters seems to have a considerable amount of code around and through it; some of it being of the "peeper" (canary) type and some somewhat more vicious.

In conclusion, let me again make the request that you mail in reports of reception for a 30 day period, so we may compare reception in all parts of the Continent. Any questions will be promptly and gladly answered. If you have any particular subject in connection with the Station Department you wish commented on, kindly voice your desires. We are getting back into the days of good reception, and I hope the programs will be coming to you from all parts of the world.

Addresses of World S. W. Stations

Europe

Call Letters Address
 ORG, ORK—Director de Communi-
 cations, Bruxelles, Belgium.
 OXY—Stateradiofonien, Heibers-
 gade 7, Copenhagen, Denmark.
 GSA to GSH—British Broadcasting
 Corp., Broadcasting House, Lon-
 don W1, England.
 English Ships—Connaught House,
 63, Aldwych, London WC2, En-
 gland.
 English Phones—GPO Radio Sec-
 tion, 86 Wood St., London EC2,
 England.
 G6RX—Rugby Radio Station, Hill-
 morton, Warwickshire, England.
 Pontoise—Minister des Postes, 193
 Rue de Grenelle, Paris, France.
 French Phones—166 Rue de Mont-
 martre, Paris, France.
 DJA to DJE and others—German
 Short-Wave Station, Broadcast-
 ing House, Berlin, Germany.
 PCK, PCV, PDV—Director, Tele-
 graph and Telephones, Parkstaat
 29, 'S-Gravenhage, Holland.
 PHI—N. Y. Phillips Radio, Huizen,
 Holland.
 DAF—Hauptfunkstelle Norddeich,
 Norden-Land, Germany.
 HAS2—Director Radio, Hungarian
 Post, Gyalı St. 22, Budapest,
 Hungary.
 I2RO—Radio 2RO—Via Asaigo, N.
 10, Rome, Italy.
 IAC—Radio Coltano, Pisa, Italy.
 IRM-IRW—Italo Radio, Via Calabria
 N 46/48, Rome, Italy.
 LCL (LKJI)—Ministere Du Com-
 merce, Administrator des Tele-
 graphes, Oslo, Norway.
 CT1AA—Antonio Augustode Aguiar,
 144 Lisbon, Portugal.
 CT1CT—Oscar G. Lomelino, Rua
 Gomez Freire 79 2 D, Lisbon,
 Portugal.
 EAQ—P. O. Box 951, Madrid, Spain.
 EA8AB—Radio Club de Tenerife,
 Alvarez de Lugo 1, Santa Cruz de
 Tenerife, Canary Islands.
 HBJ, HBQ, HBL, HBP—Informa-
 tion Section, League of Nations,
 Geneva, Switzerland.
 RNE or REN or RV59—Radio Cen-
 ter, Solianka, Moscow, U.S.S.R.
 HVJ—Radio HVJ, Castine, Pio IV,
 Vatican City, Vatican.

Asia

Japan—Stations beginning with JY:
 Government of Japan, Kemikawa-
 Cho-Chiba, Ken. Stations begin-
 ning with JV: Government of
 Japan, Nagasaki, Japan.
 Java—All Java stations: H. Van der
 Veen, Engineer-in-Charge, Java
 Wireless Stations, Bandoeng,
 Java.
 VUC—Indian State Broadcasting
 Service, Calcutta, India.
 FZS—Postale Boite 238, Saigon,
 Indo-China.

By J. B. L. Hinds

Call Letters Address
 ZHI—Radio Service Co., Broadcast
 House, 2 Orchard Road, Singa-
 pore.
 KAY and others—Philippine Long
 Distance Telephone Co., Manila,
 P. I.

Africa

CNR—Director General des Postes,
 Rabat, Morocco, Africa.
 OPL-OPM—Radio Leopoldville, Leo-
 poldville, Congo Belge, Africa.
 VQ7LO—P. O. Box 777, Nairobi,
 Kenya Colony, Africa.
 SUV, SUZ—P. O. Box 795, Cairo,
 Egypt, Africa.

South America

PPQ - PPU—Companhia Radiotele-
 graphica, Brasileira, Caixa Postal
 500, Rio de Janeiro, Brazil.
 LSX—Transradio Internacional, San
 Martin 329, Buenos Aires, Ar-
 gentina.
 LSL, LSM, LSN—Compania Inter-
 nacional de Radio, Defensa 143,
 Buenos Aires, Argentina.
 PSH, PSK—Companhia Radio In-
 ternacional do Brazil, Caixa Pos-
 tal 709, Rio de Janeiro, Brazil.
 CP5, CP7—Compania Radio Bolivi-
 ana, Castilla 637, La Paz, Bolivia.
 HC2RL—Di Roberto Levi, Director
 HC2RL, P. O. Box 759, Guaya-
 quil, Ecuador.
 El Prado—Correos, Apartado 98,
 Riobamba, Ecuador.
 HCJB—La Voz de los Andes, Cas-
 illa 691, Quito, Ecuador.
 CEC—Compania Internacional de
 Radio CEC, Santiago, Chile.
 HJY—All-America Cables, Inc., Bo-
 gota, Colombia.
 HJB—Marconi's Wireless Telegraph
 Co., Ltd., Apartado 1591, Bogota,
 Colombia.
 HKE—Observatorio Nacional de San
 Bartolome, Bogota, Colombia.
 HJ1ABB—P. O. Box 715, Barran-
 quilla, Colombia.
 HJ1ABD—Radiodifusora HJ1ABD,
 Cartagena, Colombia.
 HJ1ABE—Rafael Fuentes, Apartado
 Postal No. 31, Cartagena, Colom-
 bia.
 HJ2ABA—La Voz del Paiz, Tunja,
 Boyaca, Colombia.
 HJ2ABC—Pompilio Sanchez, Cu-
 cuta, Colombia.
 HJ3ABF—Apartado 317, Bogota,
 Colombia.
 HJ3ABD—Colombia Broadcasting
 Co., Calle 16, No. 5-40, Bogota,
 Colombia.
 HJ3ABI—Apartado 513, Bogota, Co-
 lombia.
 HJ4ABE—Radiodifusora HJ4ABE,
 Medellin, Colombia.
 HJ4ABB—Radio Manizales, Apar-

Call Letters

Address

tado 175, Manizales, Colombia. Sr.
 Roberto Baena, Prop.
 HJ5ABC—La Voz de Colombia, Ra-
 dioifusora HJ5ABC, Cali, Colom-
 bia.
 HJ5ABD—La Voz del Valle Radiodi-
 fusora HJ5ABD, Cali, Colombia.
 YVQ—H. Newman, Director Servicio
 Radiografico, Maracay, Venezuela.
 YV2RC—Broadcasting Caracas,
 Apartado 290, Caracas, Venezuela.
 YV3RC—Radiodifusora, Venezuela,
 YV3RC—Caracas, Venezuela.
 YV4RC—(Formerly YV4BSG) So-
 ciedad Anonima de Radio, Este
 10 bis N. 71, Caracas, Venezuela.
 YV5BMO—La Vox del Caribe, Radio
 YB5BMO, Maricibo, Venezuela,
 Sr. S. M. Vegas, Prop.
 OCI, OCJ—All-America Cables, Inc.,
 Lima, Peru.

Mexico and West Indies

XETE—Radio XETE, Empresa de
 Telephonos, Ericsson, Mexico,
 D. F.
 XDA, XDC—Estacion XDC or
 XDA, Secretaria de Comunica-
 ciones, Mexico, D. F.
 XAM—Director General de Correos,
 Merida, Yucatan, Mexico.
 XEBT—Radio XEBT, El Buen
 Tono, S. A., Mexico, D. F.
 COC—Short Wave Radio Station
 COC, P. O. Box 98, Havana, Cuba.
 HI1A—Radiodifusora, HI1A, Le
 Vox del Yaque, Santiago de Los
 Caballeros, Republic of Dominica.
 HIZ—Radiodifusora HIZ, Calle
 Duarte No. 68, Santo Domingo,
 Rep. Dominica.
 HIX—Radiodifusora HIX, Santo
 Domingo, Rep. of Dominica.

Oceania

VK2ME—47 York St., Sydney, N. S.
 W., Australia.
 VK3ME—G. P. O. Box 1272 L, Mel-
 bourne, Australia.
 VK3LR—61 Little Collins St., Mel-
 bourne C1, Australia.

Canada

CGA, CJA—Marconi Station, Drum-
 mondville, Quebec, Canada.
 CJRO, CJRX—James Richardson
 and Sons, Ltd., Hotel Alexandra,
 Winnipeg, Manitoba, Canada.
 VE9BJ—Capitol Theatre, St. John
 New Brunswick, Canada.
 VE9CS—Radio VE9CS, Radio Ser-
 vice Engineers, Vancouver, B. C.,
 Canada.
 VE9DN—Canadian Marconi Co., P.
 O. Box 1690, Montreal, Quebec,
 Canada.
 VE9GW—Rural Route No. 4, Bow-
 manville, Ontario, Canada.
 VE9HX—Director, Maritime Broad-
 casting Co., Ltd., P. O. Box 998,
 Halifax, N. S., Canada.

Best Short Wave Stations

The list below has been compiled from various sources, which have been checked up as closely as the difficulties of international correspondence permit. While it is not 100% accurate (no s.w. station lists of any kind are!), it will be found very useful as a foreign station tuning guide.

It was drawn up by Mr. J. B. L. Hinds. The figures at the extreme left are wavelength in meters; next to them, frequency in megacycles. Readers are invited to send in additions or corrections based on their own reception experiences. Other readers will appreciate your help.

World wide stations that send programs: B, Broadcast; E, Experimental; P, Telephone stations.

Mega-Meters	Cycles	Call	Mega-Meters	Cycles	Call	Mega-Meters	Cycles	Call
EUROPE								
13.97	21.47	B, GSH, Daventry, England, 6.00 to 8.30 a.m.	49.40	6.07	B, OXY, Skamleback, Denmark, 2.00-6.30 p.m.	49.00	6.12	B, Johannesburg, 4-6 a.m.—8-10.30 a.m.—11 a.m.-3.40 p.m.
16.30	18.40	P, PCK, Kootwijk, Holland, about 7.00 a.m.	49.83	6.02	B, DJC, Berlin, Germany, 8.45-10.30 p.m.; 12.15-4.00 p.m.	49.50	6.06	B, VQ7LO, Nairobi, Kenya Colony, 11 a.m.-2 p.m.
16.86	17.79	B, GSG, Daventry, England, 6.00-8.30 a.m., 8.45 a.m.-10.45 a.m.	50.00	6.00	B, RV59, Moscow, U. S. S. R., 2.00-6.00 p.m.	UNITED STATES		
17.77	17.77	B, PHI, Huizen, Holland, MTF 7.30-9.30 a.m., Sat. & Sun. 7.30-11.00 a.m.	60.30	4.97	E, G6RX, Rugby, England, 8.00-10.00 p.m., irregular.	16.87	17.78	B, W3XAL, Bound Brook, N. J., 9.00 a.m. to 3 p.m.
19.61	15.25	B, Pontoise, France, 7 to 10 a.m.	69.44	4.32	E, G6RX, Rugby, England, 7.00-10.00 p.m.	19.56	15.34	B, W2XAD, Schenectady, N. Y., Daily 2.00-3.00 p.m.
19.73	15.20	B, DJB, Berlin, Germany, 4.00-5.30 a.m.; 8-11 a.m.; 12.20-2.30 a.m.	ASIA			19.64	15.27	B, W2XE, Wayne, N. J., 10 a.m.-12 noon.
19.82	15.13	B, GSF, Daventry, England, 8.45 a.m.-12.45 p.m.	16.50	18.18	P, PMC, Bandoeng, Java, 3.10-9.20 a.m.	19.72	15.21	B, W8XK, Pittsburgh, Pa., 10 a.m.-4.15 p.m.
19.84	15.11	B, HVJ, Vatican City, Daily 5.00 to 5.15 a.m.—Sat. 10-10.30 a.m.	19.03	15.76	E, JYT, Kemikawa, Japan, 6.00-7.00 a.m.	25.27	11.87	B, W8XK, Pittsburgh, Pa., 4.30-10.00 p.m.
24.53	12.23	B, CTICT, Lisbon, Portugal, Sundays, 7-9 a.m., Thurs. 4-6 p.m.	20.03	14.98	P, KAY, Manila, Philippine Islands 5-7 a.m.—7-8 p.m.	25.36	11.83	B, W2XE, Wayne, N. J., 2.00-4.00 p.m.
25.00	12.00	B, RNE, Moscow, U.S.S.R., Sat. 10-11 p.m.; Sun. 6-7, 10-11 a.m.	27.93	10.38	B, JVM, Nagasaki, Japan, 4.30-7.30 a.m.	31.28	9.59	B, W3XAU, Philadelphia, Pa., 11 a.m.-7.00 p.m.
25.20	11.90	B, Pontoise, France, 10.15 a.m. to 1.15 p.m.—2.00 to 5.00 p.m.	30.49	9.84	E, JYS, Kemikawa, Japan, 4-8 a.m.	31.36	9.57	B, WIXAZ, Boston, Mass., 6.00 a.m. to midnight.
25.28	11.86	B, GSE, Daventry, England, 10.45 a.m.-12.45 p.m.	38.07	7.88	B, JYR, Kemikawa, Japan, 4.50 a.m.-7.50 a.m.	31.48	9.53	B, W2XAF, Schenectady, N.Y., 6.35 to 10.00 p.m.
25.40	11.81	B, ZRO, Rome, Italy, 11.30 a.m.-12.30 p.m.—1.15-6.00 p.m.	48.92	6.13	B, ZGE, Kula Lumpur, Malaya States, daily 8-10 a.m.	46.69	6.43	B, W3XL, Bound Brook, N. J., irregular.
25.51	11.76	B, DJD, Berlin, Germany, 5.00-10.30 p.m.; 12.15-4.00 p.m.	49.10	6.11	B, VUC, Calcutta, India, 9.30 a.m.-12 noon, Sat. 11.45 p.m. to 3.00 a.m.	48.86	6.14	B, W8XK, Pittsburgh, Pa., 4.30 p.m.-1.00 a.m.
25.53	11.75	B, GSB, Daventry, England, 12.15 a.m.-2.20 a.m.; 1.00-5.35 p.m.; 6.00-8.05 p.m.	49.42	6.07	B, PK1WK, Bandoeng, Java, Sat. 8.50-10.15 p.m.; Sun. 5-6 a.m.; daily except Sun., 4.15-6.00 a.m.	49.02	6.12	B, W2XE, Wayne, N. J., 5.00-10.00 p.m.
25.63	11.71	B, Pontoise, France, 2.00-11 p.m.	49.90	6.01	B, ZHI, Singapore, Sat. 11.00 p.m.-1.30 a.m.; Sun. 5.30-7.00 a.m., 11.00 p.m.-1.30 a.m.; Tues. and Wed. 11.00 p.m.-1.30 a.m.	49.18	6.10	B, W3XAL, Bound Brook, N. J., Tues., Thurs., Fri., Sun., 2.30 p.m.-12 mid.
29.04	10.33	E, ORK, Brussels, Belgium, 1-45-3.15 p.m.	58.00	5.17	B, PMY, Bandoeng, Java, Sat. 8.30 p.m.-1.30 a.m.; Sun., Mon., Tues., Wed. and Thurs. midnight-2.30 p.m.; Mon., Tues., Wed., Thurs and Fri. 4.30-9.30 a.m.; Fri. 10.30 p.m.-2.30 a.m.; Sat. 4.30 a.m.-10.30 a.m.	49.18	6.10	B, W9XF, Chicago, Ill., 3.30-7.30 p.m., 8.30 p.m.-1.30 a.m. Tuesday, Thursday, Friday and Sunday, 2.30 p.m.-12 midnight.
30.40	9.87	B, EAQ, Madrid, Spain, Daily 5.15-7.00 p.m., Sat. 12 noon-2.00, Sat. & Sun. 7.00-7.30 I.B.S.	60.00	5.00	B, PK3BR, Surabaya, Java, Mon.-Sat. 4.30-7.00 a.m.	49.34	6.08	B, W9XAA, Chicago, Ill., Tues., Thurs., Sat., 3.00-11 p.m.
30.52	9.83	E, IRM, Rome, Italy, Afternoons, irregular.	60.00	5.00	B, PK3GH, Surabaya, Java, daily 7.30-8.30 p.m.; 4.30-5.30 a.m.	49.50	6.06	B, W3XAU, Philadelphia, Pa., 7 p.m. 10 p.m.
31.25	9.60	B, CTIAA, Lisbon, Portugal, Tues. & Fridays 4.30-7.00 p.m.	62.00	4.84	B, PK1KR, Batavia, Java, Mon., Wed. and Sat. 7.30-9.30 a.m.	49.50	6.06	B, W8XAL, Cincinnati, Ohio, 6.30-7.00 p.m., 10.00 p.m.-2.00 a.m.
31.27	9.59	B, HBL, Geneva, Switzerland, Saturdays 5.30-6.15 p.m.	76.00	3.94	B, PK3JL, Malang, Java, Sat. 10.30 p.m.-1.00 a.m.; Sun., Tues., Wed., Thurs. and Fri. midnight-1.00 a.m.; Mon. midnight-12.30 a.m.; Fri. and Sat. 6.30-9.00 a.m.	49.67	6.04	B, WIXAL, Boston, Mass., 6.00-7 p.m.
31.30	9.58	B, GSC, Daventry, England, 6.00-8.00 p.m.	AFRICA			19.19	15.62	P, OCJ, Lima, Peru, about 2 p.m., irregular.
31.38	9.57	B, DJA, Berlin, Germany, 4.00-5.30 a.m., 8-11 a.m.; 5.00-8.15 p.m.	23.38	12.83	B, CNR, Rabat, Morocco, Sundays 7.30-9.00 a.m.	25.73	11.66	E, PPQ, Rio de Janeiro, Brazil, 7-9.00 p.m., irregular.
31.40	9.57	B, OXY, Skamleback, Denmark, 2.00-6.00 p.m.	29.58	10.14	P, OPM, Leopoldville, Belgian Congo, 9-11 a.m.—3-6 p.m.	27.35	10.97	P, OCI, Lima, Peru, 8-10 p.m., evenings, irregular.
31.41	9.55	B, LCL, Jeloy, Norway, 11.00 a.m.-5.00 p.m.	37.33	8.05	B, CNR, Rabat, Morocco, Sunday 2.30-5.00 p.m.	28.98	10.35	E, LSX, Buenos Aires, Argentina, Tests Mon., Tues., Wed. after 9 p.m.
31.55	9.51	B, GSB, Daventry, England, 12.15 a.m.-2.20 a.m.; 1.00-5.35 p.m.				30.30	9.90	P, LSN, Buenos Aires, Argentina, 6 p.m.-6 a.m. irregular.
38.47	7.80	B, HBP, Geneva, Switzerland, Saturdays 5.30-6.15 p.m.				32.02	9.37	B, HP5ABH, Palmira, Colombia 11-12 a.m., 7.30-9.30 p.m.
43.86	6.84	B, HAS, Budapest, Hungary, 3.00-5.30 p.m. irregular.				40.55	7.40	B, HJ3ABD, Bogota, Colombia, 7.30-12 p.m.
45.38	6.61	B, REN, Moscow, U. S. S. R., 2.00-6.00 p.m.				41.55	7.22	B, HKE, Bogota, Colombia, Monday 6-7 p.m., Tues., Fri. 8-9 p.m.
<i>(Continued on page 34)</i>								

Time Difference Chart

FOR the benefit of the vast majority of listeners who are troubled by the intricacies of international time, we are reprinting from WORLD RADIO (London) below a table showing the countries included in the various G.M.T. time zones. This list makes an excellent supplement to the time conversion chart which appeared on page 17 of the April, 1934 issue of SHORT WAVE RADIO. (Note: C.E.T. means Central European Time; B.S.T., British Summer Time).

G.M.T.
 *Great Britain
 *Northern Ireland
 *Algeria
 *Belgium
 *Channel Islands
 *Corsica
 *France
 *Gibraltar
 *Countries adopting Summer Time, i.e., one hour ahead of Standard Time.

WEST (Behind G.M.T.) 1 HOUR	EAST (Ahead of G.M.T.) 1 HOUR (C.E.T. and B.S.T.)
Ascension Island Canary Isles Guinea (French and Portuguese) Iceland Liberia Madeira Senegal Sierra Leone	Albania Angola Austria Belgian Congo Cameroons Czechoslovakia Denmark French Equatorial Africa Germany Hungary Italy Libya Lithuania Malta Nigeria Norway Poland Sardinia Sicily Sweden Switzerland Tunisia Yugoslavia
2 HOURS	2 HOURS
Mid-Atlantic (Azores, Cape Verde Isles)	Bulgaria Cyprus

2 HOURS Brazil (Eastern districts covering Para, Bahia, Rio de Janeiro, etc.) (Uruguay 3½ hours) British Guiana (3 hours 45 minutes)	2 HOURS Egypt Estonia Finland Greece Latvia Palestine Portuguese East Africa Rhodesia Romania Sudan Turkey Union of South Africa U.S.S.R. (West) Uganda (2½ hours)
3 HOURS Aden Iraq Kenya Colony Madagascar Somaliland Tanganyika U.S.S.R. (Central Region, including Moscow)	3 HOURS Argentina Republic Barbados Brazil (Central) Canada (Eastern districts including Nova Scotia, New Brunswick, Newfoundland, Prince Edward Island.) Falkland Islands, Grenada, Guadeloupe, Guiana (French), Leeward Islands, Martinique, Puerto Rico, St. Lucia, St. Pierre, St. Vincent, Tobago, Trinidad Venezuela (4½ hours)
4 HOURS Bahamas Brazil (Western districts) Canada (Eastern provinces, including Quebec, portion of Ontario, etc.) Chile Colombia Cuba Dominican Republic Haiti Jamaica Panama Peru U.S.A. (Eastern States, including Maine, Connecticut, New York, Florida, North and South Carolina, Virginia, Pennsylvania, etc.)	4 HOURS Mauritius Seychelles U.S.S.R. (part)
5 HOURS	5 HOURS Chagos Archipelago (Indian Ocean) India (Ceylon 5½ hours, Cutch 5 hours 53 mins.)

6 HOURS Canada (Central districts, including Manitoba, portions of Ontario, Saskatchewan, etc.) Costa Rica Honduras Mexico (East) San Salvador U.S.A. (Central Standard Time districts, including Wisconsin, Illinois, Indiana, Missouri, Iowa, Minnesota, Kentucky, Louisiana, Oklahoma, Texas, portions of Kansas, Nebraska, etc.)	6½ HOURS Andaman Burma Nicobar Islands
7 HOURS Canada (Western provinces) Mexico (Central) U.S.A. (Mountain States, including Colorado, Wyoming, New Mexico, etc.)	7 HOURS Federated Malay States French Indo-China Siam Straits Settlements Island of Sarawak (7½ hours)
8 HOURS British Columbia U.S.A. (Pacific States, including California, Nevada, Oregon, etc.)	8 HOURS British North Borneo China (East) Formosa Hong Kong Philippine Islands Port Arthur Western Australia
9 HOURS Pitcairn Islands Yukon district	9 HOURS Japan Korea Australia, South, North, and part of New South Wales (9½ hours)
10 HOURS Alaska Austral and Society Islands Low Archipelago Marquesas (Hawaii, Sandwich Isles 10½ hours)	10 HOURS Australia (New South Wales, Queensland, Victoria) New Guinea Tasmania
11 HOURS Samoa (East) U.S.A. Samoa (West) British (11½ hours)	11 HOURS New Caledonia New Hebrides New Zealand (11½ hours)
	12 HOURS Fiji Isles

Best Short Wave Stations

(Continued from page 33)

Mega-Meters	Cycles	Call	Mega-Meters	Cycles	Call	Mega-Meters	Cycles	Call
45.00	6.67	8-10 p.m.; Sunday 9 a.m.-11 a.m. B, HC2RL, Guayaquil, Ecuador, Sun. 5.45-7.45 p.m., Tues. 9.15-11.15 p.m.	50.42	5.95	B, HJ4ABE, Medellin, Colombia, Mon. 7-11 p.m., Tues., Thurs., Sat. 6.30 p.m., Wed., Fri. 7.30-10.30 p.m.	49.8	6.03	B, XEBT, Mexico City, Mexico, 7.00 p.m.-2.00 a.m.
45.31	6.62	B, PRADO, Riobamba, Ecuador, Thursday 9.00-11.30 p.m.	51.49	5.88	B, HJ2ABA, Tunja, Colombia, 1-2 p.m., 7.30-10 p.m.	31.28	9.59	B, VK2ME, Sydney, Australia, Sun. 12.30-2.30 a.m., 4.30-8.30 a.m., 9.30-11.30 a.m.
46.30	6.48	B, HJ5ABD, Cali, Colombia, 7-10 p.m.	53.00	5.65	B, HJ5ABC, Cali, Colombia, 8-10 p.m.	31.31	9.58	B, VK3LR, Melbourne, Australia, Daily except Sun., 3.15-7.30 a.m.
46.51	6.45	B, HJ1ABB, Barranquilla, Colombia, 7-10 p.m., 11.45 a.m.-12.45 p.m.	73.00	4.00	B, HCJB, Quito, Ecuador, 7.30-9.45 p.m., except Monday.	31.55	9.51	B, VK3ME, Melbourne, Australia, Wed. 5.00 to 6.30 a.m., Sat. 5 to 7 a.m.
48.00	6.25	B, HJ3ABF, Bogota, Colombia, 7-11 p.m.	MEXICO AND WEST INDIES			CANADA		
48.78	6.15	B, YV3RC, Caracas, Venezuela, 10.30 a.m.-1.30 p.m., 4.30-10.00 p.m.	25.50	11.79	P, XDM, Mexico City, Mexico, 1-6 p.m., irregular.	25.53	11.75	B, CJRX, Winnipeg, Can., daily 8.00-12.00 midnight.
49.08	6.11	B, YV2RC, Caracas, Venezuela, 10.30 a.m.-1 p.m., 5.15-10 p.m.	26.00	11.54	P, XAM, Merida Yucatan, Mexico, 1-6 p.m., irregular.	48.78	6.15	B, CJRO, Winnipeg, Manitoba, Can., 8-12 midnight.
49.20	6.10	B, HJ1ABD, Cartagena, Colombia, 11.30 a.m.-12.30 p.m., 7-9 p.m.	31.25	9.60	B, XETE, Mexico City, Mexico, 2 p.m.-2 a.m.	49.10	6.11	B, VE9HX, Halifax, N. S., 8.30-11.30 a.m., 5-10 p.m.
49.60	6.05	B, HJ3ABI, Bogota, Colombia, 8-10 p.m., irregular.	47.50	6.32	B, HIZ, Santo Domingo, R.D., Daily 4.40-5.40 p.m., Sat. 11 p.m.-12.40 a.m.	49.22	6.09	B, VE9GW, Bowmanville, Ont., Thurs., Fri., Sat. 7.00 a.m.-4 p.m., Sun. 10 a.m.-7 p.m.
50.08	5.99	B, YV4RC, Caracas, Venezuela, 4.30-10.30 p.m.	47.80	6.23	B, H11A, Dominican Rep., Daily 12.10-1.40 p.m., 7.40-9.40 p.m., Sun. 1.40-4.40 p.m., 7.40-9.40 p.m.	49.29	6.09	B, VE9BJ, St. John, N. B., 5-10 p.m., irregular.
50.25	5.97	B, HJ2ABC, Cucuta, Colombia, 11 a.m.-12 noon, 6-9 p.m.	49.50	6.06	B, HIX, Santo Domingo, R.D., Tues. & Fri. 8.10-10.10 p.m., Sun. 8.40-10.40 a.m., 2.40-4.40 p.m.	49.42	6.07	B, VE9CS, Vancouver, B. C., Fri. 12.30-1.45 a.m., Sun. 12 noon-midnight.

SHORT WAVE RECEPTION

817

less some further movement of the band is desired at a later date. In other words, the trimmer condenser permits the operator to select the particular portion of the band to be included within the tuning range.

One consideration involved in shunting a tuning condenser across only a part of a coil is that when the condenser is adjusted for minimum capacity, the coil is tuned close to its natural period. Unfortunately, the circuit resistance increases rapidly as

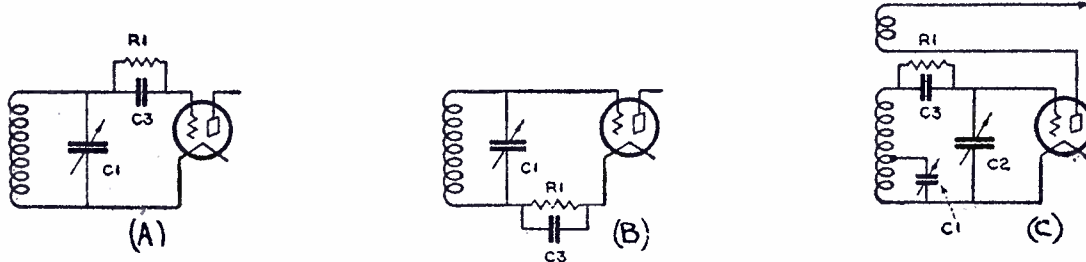

Fig. 423—Band-spread coil arrangement. (Left) The conventional detector circuit with grid-leak and condenser at the top of the coil between it and the grid of the tube. (Center) Here the grid-leak is located in the grid-return to filament line, providing the same results as at the left. (Right) The band-spread circuit showing the grid-leak and condenser in a new position.

the frequency approaches the natural period of the spread coils the shunt capacity furnished by the trimmer of the tube itself keeps the circuit well below the natural period.

Inside the band-spread type coil is a small grid-leak as an adjustable low-capacity trimmer condenser. In this arrangement, let us refer to Fig. 423. At (A) is shown a detector stage. Here, a coil is shunted by a variable condenser at one end of the coil connecting to the grid of the tube through

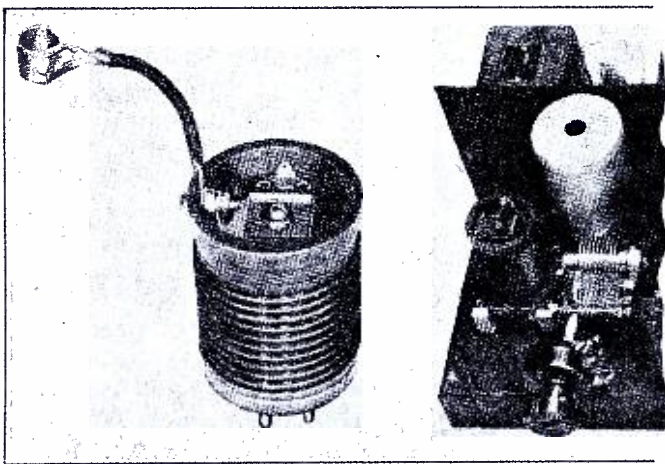

Fig. 424—A band-spread type s.w. coil is shown at the left. At its center, are the grid-condenser and trimmer of a typical s.w. receiver with the band-spread coil.

by a grid condenser, while the lower end of the coil is connected to the grid-filament return lead. (C) shows the regular variable tuning condenser of about .001 microfarads of the total inductance, while the grid leak R_1 , and

GHIRARDI'S DX DOPE

Here's just one page from Ghirardi's "monumental" RADIO PHYSICS COURSE, a reference book of nearly 1000 pages with 508 diagrams and illustrations.

Short-wave fans say it is invaluable to them not only for Ghirardi's authoritative handling of difficult short-wave questions, but also for the background it gives them in general radio and electricity. Do you want to know more about S. W. receiver construction, "band-spreading", "dead-spots", "waveband-switching" and other DX problems? Then Ghirardi's book is just what will help you most. It's clear, concise, up-to-date and easy for anybody to understand. Your short-wave reception will improve just as soon as you apply the practical principles Ghirardi gives you.

Many say this course should sell for \$50 to \$100. Our price is only \$3.85 (plus 15c for handling charges). If it isn't just what you've been looking for, return it within 10 days and we'll gladly refund your money. Mail the coupon today or send postcard for further information.

FREE CIRCULAR Send Coupon or Postcard

To: Radio & Technical Publishing Co.,
45 Astor Place, Dept. S-10, New York

- Enclosed find \$4 for 1 copy of Ghirardi's RADIO PHYSICS COURSE postpaid, with your trial guarantee.
- Please send me the free circular.
- Enclosed find \$1.75 for 1 copy of Ghirardi and Freed's RADIO SERVICING postpaid (198 pages, 121 illustrations).

Name.....
Address.....
City.....State.....
Occupation.....

Mail Coupon Today—



NATIONAL

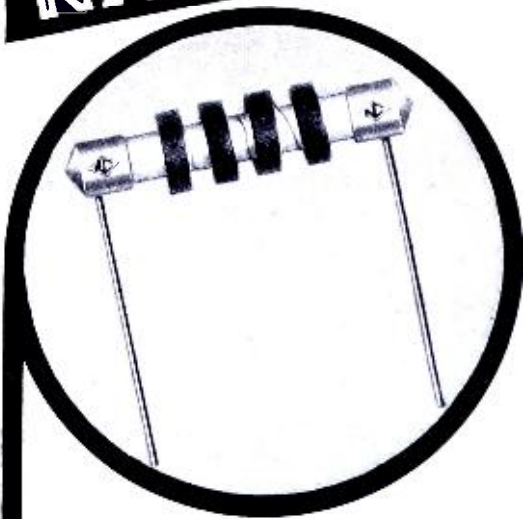

A Dependable R. F. CHOKE

Be sure you get

The Genuine NATIONAL Type 100

Don't sacrifice dependable day-in, day-out performance for a few pennies difference in R. F. Choke costs! Be sure you get the original and genuine NATIONAL Type 100 R. F. Choke. Designed for utmost convenience in installation, suitable for either grid-leak or pigtail mounting, small and compact, the Type 100 can be used close to tubes where longer leads would introduce operating difficulties. Its accurate and dependable rating adapts it to the majority of R. F. Choke requirements in modern Short Wave Receivers and Low Powered Transmitters. It is sturdy and reliable. Before you buy, look for the diamond NC trade-mark, proof of the advanced research and manufacturing facilities behind every NATIONAL RADIO PRODUCT.

Send coupon below for new
Catalogue No. 220-A

NATIONAL

TYPE 100

R. F. CHOKES



National Company, Inc.
Malden, Massachusetts

Gentlemen:

Please send me your new catalogue
No. 220-A. I enclose 6c to cover
mailing costs.

Name

Address

SWR 10



Sun Spots and Radio Reception

(Continued from page 5)

to the left shows reception points R1, R2, R3, etc. when a narrow wave is directed skyward; the right-hand diagram shows zones of reception R1-R', R2-R'', etc., when a wave of angle b is directed skyward. It is clear that variations in the angle a will change the points or zones of reception; also, for a given frequency, any variations in either the height or degree of ionization of the layer (either the E or F layers) will change the points or zones of reception.

Suppose a transmitter at T and a receiver at R1 (either diagram); further suppose that, due to outside conditions, the degree of ionization (density) of the layer increases. The immediate effect would be a change in the angle of "reflection," with the result that reception at point R1 would decrease; in the case of zones of reception, the zone would shift to the left. (For further details concerning this subject, the reader is referred to the November, 1933, issue.)

In 1928 a series of experiments was carried out by Harvard University on the relation between the number of sun spots and the reception of WBBM, Chicago; the result is shown in Fig. 2. The fewer the sun-spot numbers, the better the reception; the inverse relation holding remarkable well. Figure 3 shows the same relation for the years 1926, 1927 and 1928; the correlation here is again evident. Figure 4 shows the relation between the number of sun spots and reception of the same station, received at Perkins Observatory for the three-year in-

terval, 1930-1933. This set of curves not only shows the correlation, but indicates the decrease in the number of sun spots from about 57 to 10.

Additional data show that as the sun goes down, the intensity of the signal rises, gradually approaching a constant value. This was interpreted as a rise in the layer reflecting the signal of WBBM, which is exactly what occurs when the sun-spot number is a minimum.

The data presented so far indicate that the higher the layer the greater the signal. *This is not always the case.* A minimum number of sun spots may change the angle of reflection so as to increase the signal from a given station to a receiving point which previously had poor reception from that station. In other words, during a period of sun-spot minimum, a receiving station may be such a distance from a given transmitter that it lies within the skip-distance; hence, reception of that station would be poor. As the number of sun spots increase, the "reflected" wave reaches the earth closer and closer to the transmitter, and may eventually envelope the receiving point; reception, therefore, would be excellent.

The general conclusion, therefore, is that sun-spot maxima reduce skip distances and favor short-distance reception, while sun-spot minima increase skip distances and favor long-distance reception. The extent to which this generality holds cannot be predicted, but depends upon the number of spots, the frequency, time of day, curvature of the earth, season of the year, etc.—L. M.

A 2-Stage Preselector

(Continued from page 19)

cause of the inherent background noise of the receiver were brought way up into the clear and were perfectly understood. This trouble with weak signals is often encountered by SWL's and "hams" alike.

A Patterson receiver is used by the author for local, long-wave and short-wave phone and c.w. amateur communication. The receiver has a meter that reads the carrier signal strength in the international audibility system of R's. The scale reads from R1 to R9 plus 4. Here are some actual figures of signal strength as read on the meter:

Station	Alone	Receiver With Pre-selector
W3XAL	R5	R9 plus 3
W8XK	R6	R9 plus 4
VE9GW	R7	R9 plus 4
HVJ	R4	R9 plus 2
EAQ	R6	R9 plus 4
VK3ME	R4	R9 plus 2
W9USA	R5	R9 plus 3
W4CJ	R3	R9
W6CNE	R6	R9 plus 4

Needless to say, not only weak sig-

nals were brought away up, but correspondingly stronger signals are raised proportionately. An interesting occurrence took place when using the P-11 with receivers of the t.r.f. type. The preselector tuned signals pushed them through the receiver. In other words, the unit was more selective than the receiver itself!

Before closing, a few hints are offered to the reader. It is advised that coupling the output (RG post) to the grid cap of the first detector or first r.f. tube through the small condenser be tried. In many cases this method was found worth while. In some isolated cases it is found that the first stage of the P-11 cannot be brought up to the point of oscillation on some desired frequency. This phenomena is caused by the antenna's fundamental or harmonic resonating at that particular frequency. This can be readily overcome by placing a small variable or fixed condenser in series with the antenna at the A post of the pre-selector.

S.—C. Converter

(Continued from page 13)

separate oscillator tube is that the 6A7 does not perform very well as an oscillator at the ultra high frequencies, it often being necessary to shunt the triode portion, which is usually the oscillator, with an additional triode in order to step up the oscillator voltage at the higher frequencies. Of course, this defect is eliminated with the mode of connection shown.

The output of the converter is coupled to the receiver through choke L14, L15, C16, C17 and C18. C18 is merely a coupling condenser which prevents the plate voltage from being fed directly to the receiver. The remaining part of the output circuit may be analyzed as follows. The circuit L14, C16 and C17 is adjusted to resonance at 545 kilocycles, the frequency to which the receiver must be tuned. This is accomplished in the factory, but a small screw head protruding from the chassis permits a final adjustment to be made during installation. This circuit also acts as a filter, and bypasses any higher frequencies to ground. The voltage drop across L15, which is effectively connected across C17 as far as r.f. is concerned, is applied to the receiver through C18.

This completes a brief analysis of the outstanding features of this converter. The tubes used in the remaining connections may be determined by reference to the schematic diagram. This receiver was operated every evening for about ten days with a Colonial model 650, and the results were really phenomenal. The gain in this converter when added to that of the receiver itself produced such high volume that the volume control on the receiver had to be turned down to almost zero for comfortable room volume on the usual foreign locals such as England, France, Spain, Germany, etc. Then, too, there was so much signal strength that the a.v.c. in the receiver took hold quite easily, with the result that there was practically no background noise, and reception was clear and steady.

In a way, this had a bad psychological effect on your technical director, as he found it difficult to leave this combination and go back to the usual short-wave receiver in which the gain has to be pushed up to the hilt before satisfactory performance could be obtained.

There seems to be some aversions to using short-wave converters. Some people are under the impression that in combination with an ordinary broadcast receiver, the results are not as good as with a straight short-wave set. All one need to do is use a modern converter with even a mediocre set, and all fears will be dispelled.

The bug in the bonnet is merely the proper design.—L.M.

HAMMARLUND'S First Low-Priced S-W COILS

Wound on New XP-53
High-Efficiency Forms



LOW-PRICED Hammarlund S-W Coils are now available, due to the perfection of "XP-53", the sensational new Hammarlund low-loss dielectric.

Rugged, durable, good looking, no artificial coloring. Ribbed for air-spacing. Easy flange-grips, with "meter-index" inserts for wavelength marking. Molded shelf inside coils for mounting Hammarlund trimming or padding condensers.

Set of 4 coils (4 prongs, 2 windings)
for 15-220 meters. \$3.00 list.

Set of 4 coils (6 prongs, 3 windings)
for 15-220 meters. \$3.75 list.

Other coils for lower or higher ranges. Silver-plated, low-loss secondaries on higher-frequency coils.



New Hammarlund XP-53 Low-loss Coil Forms, 4, 5 or 6 prongs, 35c each list.



HAMMARLUND MANUFACTURING CO.
424-438 W. 33rd St., New York



— Check here and attach 10c for 16-page Hammarlund 1935 Short Wave Manual, illustrating and describing most popular S-W circuits of past year, with schematic and picture diagrams and parts lists.

— Check here for FREE information on XP-53 Coil forms and Coils.

— Check here for FREE General Catalog.

Name.....

Address.....

.....SR-10



more than

50,000 stations

are listed in the new edition of the

RADIO AMATEUR CALL BOOK MAGAZINE

This unique "telephone book of the air" is without equal anywhere in the world. Indispensable to every short-wave amateur and experimenter. Contains ALL amateur calls, high-frequency commercial stations, press, time and weather stations, etc. 288 pages, 8³/₄ x 12 inches. Price

\$1.10 postpaid.

Standard Publications, Inc. 192 Lexington Ave., New York, N. Y.

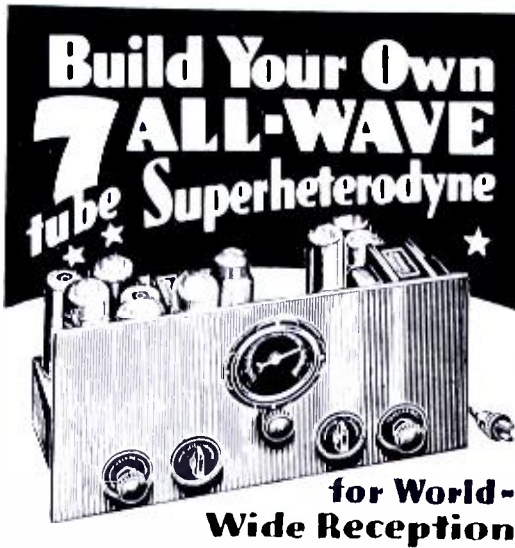

★ CONTINUOUS BAND-SPREAD ★
ALL-STAR
 ALL-WAVE Superheterodyne

Designed and Sponsored by 8 Leading Manufacturers: Meissner—Thordarson—Cornell-Dubilier—Hammarlund—Belden—Ohmite—Crowe—Electrad

Remarkable New Design

A truly professional communication receiver that can be readily assembled without the use of special tools or test equipment. Among the many features of the ALL-STAR circuit are:

CONTINUOUS BAND SPREAD—over the entire tuning range makes possible the separation of hundreds of stations that are jammed together at a single spot on the ordinary receiver dial.

BEAT-NOTE OSCILLATOR—electron-coupled, an absolute necessity for code reception and greatly facilitates tuning of distant broadcast stations. Controlled by convenient panel switch.

10 to 500 METER TUNING RANGE—Continuous without any skips. Covers the two-way 10 meter police band.

SEVEN-TUBE SUPERHETERODYNE CIRCUIT—2A7 oscillator and first detector, 58 first i. f., 58 second i. f., 56 second detector, 2A5 power output pentode, 80 rectifier, and 58 electron-coupled beat-note oscillator.

ALL A. C. OPERATION—Built-in power unit supplies all voltages. Special design for hum free short-wave reception.

PRE-ADJUSTED COILS—Oscillator and i. f. coils are pre-set at the factory, eliminating all difficult adjustments or need of test instruments.

Only \$2.50 Starts You Building

Ask your jobber for the ALL-STAR Receiver foundation that includes drilled sub and front panels, enlarged drawings of wiring and pictorial diagrams, and complete information for wiring, adjustment, and tuning. Then buy the remaining parts as you need them in convenient payments to suit your pocketbook.

Ask Your Jobber or Write Today!

SPONSORED BY

- | | |
|--|--|
| Meissner Mfg. Co.,
2815 W. 19th St.,
Chicago, Ill. | Belden Mfg. Co.,
4647 W. Van Buren St.,
Chicago, Ill. |
| Thordarson Electric
Mfg. Co.,
500 W. Huron St.,
Chicago, Ill. | Ohmite Mfg. Co.,
636 N. Albany Ave.,
Chicago, Ill. |
| Cornell-Dubilier Corp.,
4377 Bronx Blvd.,
New York, N. Y. | Crowe Nameplate &
Mfg. Co.,
1749 Grace St.,
Chicago, Ill. |
| Hammarlund Mfg. Co.,
424 W. 33rd St.,
New York, N. Y. | Electrad, Inc.,
173 Varick St.,
New York, N. Y. |

Please send free copy of big circular showing photographs of completed ALL-STAR Receiver, parts list, and wiring diagram.

Name.....
 Address.....

A 75cm Transmitter and Receiver

(Continued from page 17)

of the transmitter. Regardless of the method of coupling, their length should be adjusted so as to give a slight dip in the plate current. More elaborate antenna systems having directional properties may be arranged later, but it is best to use a simple arrangement until everything is working properly.

Now that signals are being sent out, the first receiver may be constructed. It may consist of another pair of stiff wires connected to a crystal detector bridged by a pair of head-phones, Fig. 3. The receiver is held near the transmitter and the length of the wires is adjusted until the signal, a 120-cycle hum from the power supply, is heard to best advantage. The range of this simple receiver is only a few feet, but it is advisable to use it in the preliminary work.

A more sensitive receiver is shown schematically in Fig. 4. Its construction is the same as that of the transmitter, and it is put into operation in the same manner. In this case, a better filtered power supply should be used. Batteries are to be preferred, although their life is rather short. In order to test the receiver, place it within a few feet of the transmitter. Make sure the latter is operating properly by trying the crystal receiver. Then apply the same voltage to the grid of the receiving tube as that applied to the transmitter. Tune the receiver by sliding the condenser bridge away from the tube until the point of oscillation is indicated by a rise in plate current. Then check the frequency with the wave-meter. If it agrees with that of the transmitter, the signal can be heard by slightly detuning the receiver. It may be necessary to change the grid voltage a trifle to compensate for slight differences in tube structure. This may be determined by trial.

Once the transmitter and receiver are adjusted, it is advisable to fasten the bridge condensers with a drop of solder. This will make it possible to move them about with little danger of detuning.

A large field of experimentation is open to the amateur who has constructed these two units. A study of field strength around buildings is of particular interest. If the equipment can be taken into rolling country, the shadow effects of hills offers a splendid field of investigation. Phone transmission may be tried. Absorption modulation is perhaps the easiest, but better results will be obtained if the audio voltage is impressed upon the plate circuit of the transmitter by means of a coupling transformer. Directional transmission should certainly be tried. The dimensions of antenna systems for such short waves as these make possible quite complicated systems at small cost.

Such kinks as develop can probably be ironed out if the following points are remembered.

1. Oscillation is indicated by the presence of a plate current greater than 250 microamperes.

2. Heating of the grid is to be expected, but it should not be allowed to become incandescent. The grid current should not be greater than 100 milliamperes. A current of at least 25 ma. is necessary.

3. A blue glow in the tube indicates the presence of gas. If this is the case, discard the tube. It will not operate properly.

4. Some tubes will not oscillate due to structural dissymmetry.

5. It may be necessary, in some cases, to use radio-frequency chokes in the cathode and heater leads. The efficacy of the chokes may be tested by bringing the hand near the leads. If this causes any change in the plate current when the tube is oscillating, the choking action is insufficient and more turns should be used.

Do not expect too much from the equipment. A range of a mile is real DX. In many cases, room-to-room communication is all that can be accomplished. Remember, also, that such a transmitter as this must be licensed and must be operated within the assigned frequency band.

Photographs

We have received a number of photographs of the transmitters of many foreign short-wave stations, and have reproduced them in this and past issues of SHORT WAVE RADIO.

We would like to extend, at this time, an invitation to any foreign station to send in photographs of the transmitter, as almost every short-wave listener likes to see pictures of the apparatus that he hears. The photographs of the transmitter at the U.S.S.R., reproduced on this and on another page in this issue were sent to us directly.

While on the subject of photos, it might not be a bad idea to have some of you listeners, with neat or unique receiving stations to have a few pictures taken (although one is usually enough) and send them (or it) to us for reproduction.



Generator room at RV59, U.S.S.R.

A Regenerative 2-Tube Converter

(Continued from page 16)

Set the broadcast dial for 600 kc. and turn on plenty of volume.

Set both the main tuning condenser and padding condenser on the converter nearly all in mesh and fish around for a broadcast station between 1400 and 1500 kc. These frequencies are better for lining-up purposes because of the strong, steady signals they afford. Back off on the volume and juggle the broadcast dial, converter dial, and padding condenser for best volume.

Now, with a bakelite screwdriver, adjust all i.f. transformers for loudest signal, beginning at the right and going to the left. Then go over them a second time for a careful touching up.

For best selectivity, the coupling condenser should be set as open as possible without weakening the signal. Each time this is changed, the secondary screw on the last i.f. transformer must be readjusted.

Leave the A coils in and now tune for some amateur 'phone around 160 meters. The padding condenser must be opened up a bit. You may experience some squeals here, because there is frequently a heterodyning action between amateur stations, due to their close proximity. Finish exploration of the A-coil band by looking for some police calls around 122 meters.

Next, try the B coils. Aircraft are heard around 100 meters, but since they go on and off suddenly, getting them is "catch-as-catch-can." There is an active amateur 'phone band from 75 to 77 meters, which is often quite interesting.

Now place the C coils in their sockets and look for the 49-meter broadcast band, which is about the center of the dial. You will find a number of American, European and South American stations there. The padding condenser must be set about a quarter in mesh for this band, and progressively less for the D, E, and F bands.

Almost everything in the D band is code, but you will find the 31-meter broadcast band with the two-gang condenser about 1/3 in. There are only certain times each day when the 31-meter band is active, so don't be disappointed if you fail to find it the first time.

The 25-meter band is best from mid-afternoon to about 10 P.M. GSD and DJD come roaring in during this time. They are close together and must be tuned carefully to avoid heterodyning between them.

The detector coil for this band should be adjusted for tracking by spacing the turns on the detector grid winding until the setting of C5 remains the same with main dial set at 10, 50 and 90; then cement the turns in place.

You will find two background

noise levels and signal peaks with the padding condenser. Use *only* the one with condenser *open widest*, avoiding the other peak.

At this particular time, there is so little activity below 18 meters that it is scarcely worth while to wind coils for that region. If you do wind them, adjust the detector coil as instructed for the 25-meter band.

Band-Spreading

After you have become familiar with operation using full-coverage coils, you can wind coils for band-spreading. Wind the G set first. Set the band-spread condensers C3 and C4 exactly 1/4" open, measured from tip of movable plate to isolantite base.

Insert the coils and write down the settings for all stations heard. There are several desirable stations outside the 49-meter band, so that it is desirable to cover from 45 to 54 meters with these coils. HJ1ABB, Barranquilla (46 1/2 meters), should be located with the two-gang condenser about a third open to insure getting down to 45 meters. Should you not find them at this point after having first found them on the full-coverage coils, remove one-eighth turn from oscillator coil. Adjust condensers C3 and C4, turning each screw exactly the same amount, until DJC is located with the two-gang condenser three-quarters in mesh. Compare the tracking at 10 and 90 on the dial. If incorrect, adjust C3 until maximum volume is heard with C5 at the same setting.

Now wind the H coils, but do not cement. Do not change the setting of C3 and C4. Spread the turns slightly until GSD and DJD are located with the two-gang condenser one-eighth in mesh. Cement the oscillator coil and adjust the detector coil for tracking with C5 also one-eighth in mesh, first being sure that this is set on first peak.

This set of coils was designed for the 25-meter band with the oscillator operating at a *lower* frequency. They will also work perfectly for spreading the 31-meter band by working the oscillator at a *higher* frequency than the signal. Just turn C5 half-way in (to the second noise background peak) and look for stations with the two-gang condenser approximately three-quarters in mesh.

These band-spread coils make tuning a real pleasure. Short-wave stations are tuned and logged just as easily as broadcast stations!

Operating Suggestions

Should you have a local broadcasting station on 600 kilocycles, retune the intermediates until interference

(Continued on page 42)

FOREIGN RECEPTION

WEAK?

Get more power, clearer tone with

RCA SPECIAL NOISE-REDUCING ANTENNA

THE greatest advance in the development of short-wave antennae. RCA engineers have perfected a new all-wave double-doublet antenna system that gives greater signal pick-up and reduces man-made noise to a minimum. Higher efficiency because parts are scientifically matched. Also improves standard broadcast reception. Easy to install. No bulky transposition blocks. "Unquestionably superior to anything we've tried so far," said Martin Gosch, Radio Columnist of New York Post Syndicate Newspapers. Kit of essential parts, List Price \$6; or have your dealer or service engineer make a Certified Installation.



In the heart of the South, Wholesale Radio Service Company opens a New Branch dedicated to the principle that Servicemen far from the manufacturing and buying centers of the Radio World are entitled to the same low prices, complete stocks, fast service and low transportation costs as those in the North.

Our great modern Atlanta salesrooms will display the most varied and complete line of replacement parts by every leading manufacturer. There will be a special department devoted exclusively to P. A. equipment while Short Wave sets, Kits and equipment will be featured.

For 13 years we have pledged ourselves to sell Quality Merchandise at lowest wholesale prices... and in Atlanta—as in New York and Newark—this pledge will be fulfilled. Servicemen, Amateurs, Hams, Brasspounders and Experimenters all will welcome this New Branch in Atlanta—now the RADIO CAPITOL OF THE SOUTH!

For copy of latest catalog please write Dept. SWR-104

WHOLESALE RADIO SERVICE CO.
100 SIXTH AVE. 430 W. PEACHTREE ST. N.W.
NEW YORK, N.Y. ATLANTA, GA.

★ CONTINUOUS BAND-SPREAD ★
ALL-STAR
 ALL-WAVE Superheterodyne



New
 "Build-It-Yourself"
ALL-WAVE SUPERHET!

A revolutionary sensation in the Short Wave field! Eight leading manufacturers put their heads together—drew upon all their designing and manufacturing experience. Result: This Great 6-Tube All-Wave Superhet That Outperforms Anything of its Kind! Features that guarantee good foreign reception include: Continuous Band Spread, 10 to 500 Meter Tuning Range, Pre-Adjusted Coils, etc.

Buy at "WHOLESALE" PRICES

Be sure to write us first. Get complete circuit diagram, parts list and data sheet—everything FREE. Always deal with "The House of Radio Reliability" — Address Dept. SWR-104X.

WHOLESALE RADIO SERVICE CO., INC.
 100 SIXTH AVE. 430 W. PEACHTREE ST. N.W.
 NEW YORK, N.Y. ATLANTA, GA.

NEWARK BRANCH: 219 Central Ave., Newark, N. J.

1818 Pages of Information!
"THE HANDBOOK OF CHEMISTRY AND PHYSICS"

FOR twenty years the Handbook of Chemistry and Physics has been giving a unique service to those in need of accurate tables, formulas and scientific data in a single convenient volume.

Constant revision, year by year, brings you, in this 20th Anniversary Edition, 1818 pages of the most up-to-date data procurable. With the Eighteenth Edition available, you do not need to rely upon obsolete reference works, incomplete data or original papers which are often hard to locate. Of particular interest to the radio experimenter are the greatly enlarged table of characteristics of Thermionic tubes, dozens of valuable tables of mathematical functions and formulas and numerous chapters on sound, electricity and light.

This handbook is generally regarded as the most complete single reference book for the scientific worker. It is the kind of book that you will keep on your desk or work-table, not in the bookcase.

Price \$6.00 postpaid

order from
STANDARD PUB. INC.,
 192 Lexington Ave. New York, N. Y.

Divisions of the F. C. C.

(Continued from page 7)

- Aeronautical Point-to-Point
- Airport
- Aircraft
- Aeronautical Aircraft
- Coastal Telegraph
- Coastal Harbor (Telegraph)
- Coastal Telephone (2)
- Coastal Telegraph
- Coastal Harbor (Telegraph)
- Coastal Telephone (2)
- General Experimental (3)
- Special Experimental (3)
- Geophysical
- Point-to-point Telegraph
- Point-to-point Telephone (2)
- Point-to-point Telegraph
- Municipal Police
- State Police
- Special Emergency
- Marine Fire
- Point-to-point Telegraph
- Marine Relay
- Mobile Press
- Point-to-point Telegraph
- Amateur
- Motion Picture
- First Class (4)
- Second Class (4)
- Third Class (4)
- (2) Stations in Alaska only.
- (3) All stations of this class except those assigned by designations (1) and (6) to the Broadcast Division

and Telephone Division respectively.

(4) Except ship telephone stations connecting through coastal telephone stations with the public telephone network.

III. TO THE TELEPHONE DIVISION
 Service

- Fixed Public
- Public Coastal
- Private Coastal
- Experimental
- Ship

Class of Station

- Point-to-point Telephone
- Coastal Telephone (5)
- Coastal Harbor (Telephone) (5)
- Coastal Telephone (5)
- Coastal Harbor (Telephone) (5)
- General Experimental (6)
- Special Experimental (6)
- First Class (7)
- Second Class (7)
- Third Class (7)
- (5) Except stations in Alaska.
- (6) All matters relating to or connected with the research, development and operation of public telephone service.
- (7) Ship telephone stations connecting through coastal telephone stations with the public telephone network.

Stations HBL and HBP

THE voice of the League of Nations may be heard every Saturday night at 5:30 P.M. through stations HBL and HBP simultaneously, the former on 9585 kc. (31.3 meters) and the latter on 7800 kc. (38.47 meters).

Programs are given in three languages, as follows: English, 5:30 to 5:45; French, 5:45 to 6:00; Spanish, 6:00 to 6:15, E.S.T.

The subject matter consists of a bulletin of the week's events connected with the work of the League, or a talk on some particular aspect of that work of topical interest. Special broadcasts are given at frequent intervals on other days of the week at about the same time as the regular Saturday broadcasts.

The transmitters are rated at 20 kw. each. One was constructed by Marconi and tunes from 14 to 100 meters. The other was constructed by the *Societe Francaise Radio-Electricite* and covers the band from 14 to 40 meters. Directional or non-directional antennas are used according to requirements.

* * *

Dynamic speakers are notoriously bad on weak signals. To see how bad some of them really are, go to your broadcast set, tune in a good station, turn the volume control to nearly zero and listen.

The "lows" will disappear and the "highs" will sound tinny. This is due to magnetic leakage in the speaker.

A New S. W. Converter

(Continued from page 41)

is avoided. These coils will work equally well for any intermediate frequency from 540 to 650 kilocycles.

This converter works just as well with either a t.r.f. or superheterodyne broadcast set. It is possible, but very unlikely, that a whistle will be heard when used with the latter if the manufacturer did not shield well. Should this occur, simply change the intermediate frequency slightly.

There is a prevalent impression that short-wave converters must be located as closely as possible to the broadcast set. However, this converter has actually fed a neighbor's set 37 feet away, with no noticeable loss on European stations. So if you wish to place the converter on a table five or six feet away, go ahead. The volume control on the converter will certainly prove its convenience.

To make the converter regenerate, merely take a piece of hook-up wire about 4" long and run it alongside the 58 tube, inside the shield, and wrap one end around the grid cap. After a little experimentation with the length and position of this wire, oscillation will take place with the volume control full on.

Backing off on the volume control will make the tube regenerate, resulting in considerably increased volume and sensitivity. It is well to check up, now, on the adjustment of the i.f. transformers.

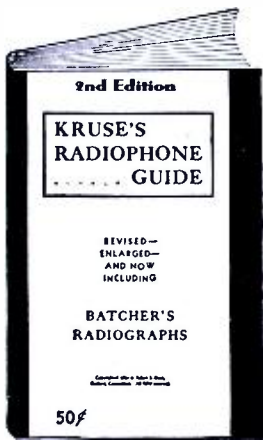

Twice as Big as Before!
is
the new
2nd edition
of

KRUSE'S RADIOPHONE GUIDE

and just as full of operating and constructional information which isn't printed elsewhere.

And furthermore—
There's a complete set of,

Batchers "Radiographs"
the simplest problem-solvers we ever saw.

IN STOCK AT—

Thompson Holmes, San Francisco
Walter Ashe Radio Co., St. Louis
G. M. & C. Radio Sup. Co., Oakland
Zuck Radio Sup. Co., San Francisco
Radio Specialties Co., Detroit
Warner Bros., San Francisco
E. C. Wenger Co., Oakland
Leeds, New York
Offenbach Elect. Co., San Francisco
I. S. Cohen's Sons, San Francisco
Neisner Bros., Inc., Boston
J. C. Hobrecht Co., Sacramento
Portland Radio Sup. Co., Portland
Griffith Sales Co., Tacoma, Wash.
Wedel Co., Inc., Portland
Wedel Co., Inc., Seattle
Seattle Radio Sup. Inc., Seattle
Lou Bonn Co., St. Paul
Chicago Radio Apparatus Co., Chicago
Spokane Radio Co., Inc., Spokane
Midwest Radio Mart, Chicago
Gross Radio, Inc., New York
Intercity Radio Stores, Long Beach
American Sales Co., New York
Burstein-Applebee Co., Kansas City
Abbott's Sweet Shop, Berwyn, Ill.
T. F. Cushing, Springfield, Mass.
Ports Mfg. Co., Fresno
Radio Inspection Service, Hartford
Radio Supply Co., Los Angeles
Harty & Young, Hartford
Kronson Service Co., Buffalo
Pierson's Radio Laboratory, Sacramento
Blair the Radio Man, New York
Wilmington (Delaware) Elec. Specialties Co.
Kladag Radio Laboratories, Kent, Ohio
Maurice Schwartz & Son, Schenectady
Harry's Radio Land, Long Beach
Radio Service Laboratory, Manchester, N. H.
Thompson Battery and Radio Service, Zanesville
Radio Laboratories, Kansas City
Radio Electric Service Co., Philadelphia
Chicago Radio Apparatus Co., Chicago
Cameradio, Pittsburgh
Natick Book Store, Los Angeles
Radio Distributing Co., South Bend, Ind.
Radio Television Sup. Co., Los Angeles, Cal.
Neisner Bros., Rochester, N. Y.
Electric Supply Co., Oakland, Cal.
Coast Electric Co., San Diego, Cal.
McGills, Melbourne, Australia
Radio Supply Co., Oakland, Cal.
Uncle Dave's Radio Shack, Albany, N. Y.
Thompson Elect. Co., Manila, P. I.
Radio Sales Service, Ltd., Vancouver, B. C.
W. H. Edwards & Co., Providence, R. I.
Sun Radio, New York, N. Y.
San Francisco Radio Exchange, San Francisco, Cal.
S.O.S. Radio Co., Honolulu, T. H.
Radio Equipment Sales Co., Detroit, Mich.
S.O.S. Radio Sup. Co., LaCrosse, Wis.
Inter-State Radio & Supply Co., Denver, Colo.
M. & H. Sporting Goods Co., Philadelphia, Pa.

50 cents from your dealer (75 cents in Canada) or direct from

Robert S. Kruse
Guilford, Conn.

Amateur Licenses

(Continued from page 27)

transmitters in moving vehicles. There was a very strict rule against this during prohibition, but that's all over now.

The short waves are getting shorter and shorter. To encourage experimentation, the government now permits amateurs unlimited privileges on all wave lengths below 2.72 meters (above 110 megacycles). These sound somewhat useless, but it wasn't so long ago that everything below 200 meters was considered useless too, and the commercial interests thought they were getting rid of a nuisance when the amateurs were "sunk" there.

Ever since 1912, when the first national act regulating radio communication in the United States was passed by Congress, the government has been most liberal in its dealing with amateurs. For fifteen years about all the Department of Commerce radio inspectors did in connection with amateur radio was to issue licenses and to draw its own personnel from amateur ranks. The amateurs were comparatively few in number, they had plenty of space to work in, and strict supervision was not necessary. In recent years, however, the game has grown to enormous proportions—there are now about 50,000 licensed amateurs in the United States alone—and black sheep are bound to appear. The present Communications Act of 1934 has been provided with some real teeth, just in case some of these black sheep get frisky and endanger other members of the flock. A license is easy to get and you're quickly detected if you try to operate without one, so there is no sense in risking the \$10,000 fine, or two-year imprisonment that awaits offenders convicted of having unlicensed stations.

It is highly advisable to join a nearby amateur club. You will meet a lot of fine fellows, and the more experienced members will be glad to give you help on technical problems. A list of the clubs affiliated with the American Radio Relay League, the national organization of radio amateurs, may be obtained without cost from its headquarters at West Hartford, Conn.

People without any previous experience can become highly competent radio amateurs merely by reading the excellent books on the subject. For an investment of less than three dollars you can obtain four pieces of literature that will not only get you started in the ham game, but also keep you going for a couple of years. We specifically recommend "The Short Wave Radio Handbook", by Denton; "The Radio Amateur's Handbook", by the headquarters staff of the A. R. R. L.; and "How to Become a Radio Amateur" and "The Radio Amateur's License Manual".



HIGH FREQUENCY BY-PASS CONDENSERS

ANOTHER Sprague development of utmost importance to every amateur and short wave fan. . . .

. . . Oil-impregnated Short Wave Condensers guaranteed as excellent substitutes for mica condensers in any of the circuits illustrated. And look at the prices!—from 50% to 75% less than you have been paying for mica units.

Just the thing for by-pass purposes in Short Wave receivers, although they are not recommended as series padding condensers or as mica substitutes in tuned circuits. Thus, while not a universal substitute for mica, Sprague Short Wave Condensers CAN be used with entire safety and effectiveness in the circuits mentioned.

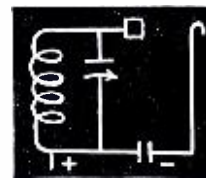

BY-PASS

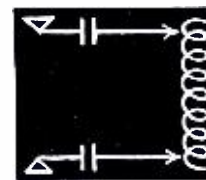

COUPLING (Ant.)

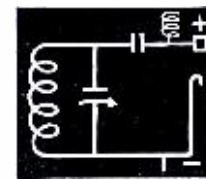

BLOCKING

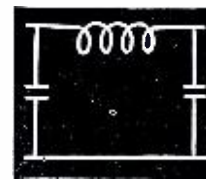

FILTERS (Fone)

YOU JUST CAN'T BREAK THEM DOWN. TESTS AT HEAVY CURRENT AND TREMENDOUS HEAT HAVE SHOWN NO FAILURES. QUALITY AT A PRICE BECAUSE OF NEW, IMPROVED CONSTRUCTION. OIL CONDENSERS ARE ALWAYS THE BEST.

Sturdy—self-supporting. Unusually small—from one-third to one-half as large as mica condensers of the same ratings. Metal encased—non-inductive—extremely low power factor—impregnated with a specially developed oil—1500 V. and 1000 V. continuous D. C. rating. Guaranteed unconditionally when used as specified. Sold by leading jobbers. TRY THEM TODAY!

Write for our complete Condenser Catalog including famous Sprague Transmitting Condensers

Cat. No.	Capacity	D. C. Working Voltage	Diam.	Length	List	Net
SW-22	.002	1500	9/16"	by 1 9/16"	\$.45	\$.27
SW-25	.005	1500	5/8"	by 1 13/16"	.45	.27
SW-11	.01	1500	1 1/16"	by 1 13/16"	.70	.42
SW-15	.05	1000	7/8"	by 2 1/4"	.80	.48
SW-1	0.1	1000	7/8"	by 2 1/4"	.90	.54

SPRAGUE PRODUCTS CO.,

North Adams, Mass.

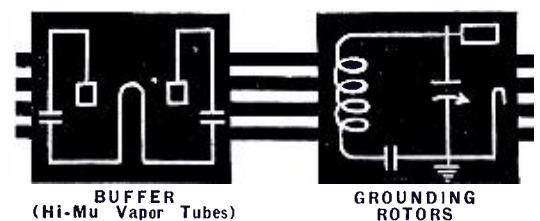

BUFFER (Hi-Mu Vapor Tubes)

GROUNDING ROTORS

Greatest Value on the Market



The
All-Electric
3
SHORTWAVE
RECEIVER

Uses special circuit for 6F7 (2 tubes in 1 bulb) and 1V tubes as regenerative detector, audio amplifier, rectifier and complete built-in power supply. Operates entirely from 110 volt ac or dc house lighting circuit. Sensitive lamp-free, and good volume. Covers 18-215 meters. Owners report reception of European, South American, Hawaiian, and numerous American stations. Heavy, black crackle finish chassis and panel. Weight 6 lbs. Coils for 18-215 M and instructions included. Foreign reception guaranteed. Circular on request.

KIT ASSEMBLED
\$6.25

Wired and Tested
Extra \$1.45
Arcturus Tubes \$1.90
Broadcast Coils .95

EILEN RADIO LABORATORIES
Dept. SWR3, 463—4th Avenue, New York City, N. Y.

DON'T BUY ANY ANTENNA SYSTEM

before getting details of the two new
patented and guaranteed
LYNCH "HI-FI" ANTENNA SYSTEMS
(High Fidelity)

Reception completely revolutionized
on wave lengths from 3 to 650
meters. It's fun to be fooled—but it's
more fun (and better business) to
KNOW. Investigate before you buy.

At Leading Radio and Dept. Stores,
or Write Us for Full Details

ARTHUR H. LYNCH, INC.
227 Fulton St., New York, N. Y.

ALL ELECTRIC ALL-WAVE AIR SCOUT

ONLY SET OF ITS KIND IN THE WORLD

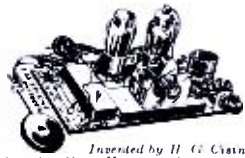

This powerful little set operates directly from any house lighting circuit, either a.c. or d.c. It brings in all standard broadcast stations and also police calls, foreign stations, code and trans-Atlantic phone conversations. Uses five plug-in coils to cover band from 10 to 550 meters. Compact and light—makes an ideal portable. Will operate several headsets simultaneously and will work on a short indoor aerial.

COMPLETE SET, with two tubes, earphone, two coils covering band from 70 to 550 meters, ready to plug in and use.....Postpaid **\$8.50**
Same as above, less earphone.....Postpaid **\$8.00**
Three extra plug-in coils to cover band from 10 to 70 meters—50c each.

Battery-Operated All-Wave Air Scout complete with tube, earphone, two coils, ready to use (less inexpensive batteries).....**\$5.95** postpaid
SPECIAL OFFER: Valuable data on All-Wave Receivers sent upon receipt of 10c to cover handling costs. Free circulars also available.

ALLIED ENGINEERING INSTITUTE

Est. 1921
98 Park Place - Dept. RHH - New York, N. Y.
Phone BR4rday 7-9540

Want to Subscribe?

See Page 48.

Who's Who in the FCC

Chairman E. O. Sykes

JUDGE EUGENE OCTAVE SYKES, who was named by President Roosevelt chairman for a term of 7 years, is one of the five original members of the Federal Radio Commission and started to serve on that body when it was first organized March 15, 1927. At that time he was named vice-chairman and served in that capacity until he was elected chairman March 21, 1933, a position he held until the Federal Radio Commission was abolished by enactment of the Federal Communications bill.

Judge Sykes was born at Aberdeen, Miss., on July 16, 1876. He received his academic training at St. John's College, Annapolis, a noted institution of learning, the third oldest college in the United States, and at the United States Naval Academy. He received his LL.B. degree at the University of Mississippi in 1897, and then began the practice of law at Aberdeen, Miss. He was Democratic presidential elector-at-large from Mississippi in 1904.

In 1916 Judge Sykes was appointed a Justice of the Supreme Court of Mississippi and soon afterwards was elected to the same office for a term ending 1925. He voluntarily retired from the bench in 1925 and resumed the practice of law.

Judge Sykes has attended several international radio conferences in an official capacity in recent years. He was named by President Coolidge chairman of the American delegation to the North American Radio Conference held in Ottawa in 1929. President Hoover appointed him chairman of the American delegation to the International Radio Conference held in Madrid in 1932, which lasted from early September until the end of December. At Madrid he was named chairman of the important technical committee. President Roosevelt named him chairman of the U. S. delegation to the North and Central American regional radio conference held in Mexico City in 1933.

Judge Sykes is a member of the Delta Kappa Epsilon, a Mason, an Elk, and a member of the Sons of Confederate Veterans. His home is at Jackson, Miss.

Colonel Thad H. Brown

COLONEL THAD H. BROWN was born and reared on a farm in Lincoln Township, Morrow County, Ohio. He has always manifested keen interest in farming and stock raising, and in farmers' problems. For years he has owned and supervised farms of his own in his native state.

Colonel Brown attended country school and was graduated from high school, following which he taught school for one year.

He is an alumnus of Ohio Wesleyan and Ohio State Universities and was admitted to practice law in Ohio in June 1912, and in 1930 he was admitted to practice before the Supreme Court of the United States.

He served 19½ months from July 1917, in the army during the World War. He entered as a Captain and was a Major upon retirement. He has been a Colonel in the Officers' Reserve Corps for the past eleven years.

He was appointed a member of the State Civil Service Commission of Ohio, February 1, 1920, by Governor James M. Cox, and served on that Commission until his resignation to qualify for Secretary of State of Ohio.

From 1919 to 1920 he was Second Post Commander of Franklin Post No. 1 at Columbus, the largest post, numerically, in the state.

From 1920 to 1921 he was Chairman of the Americanization Committee of the American Legion of Ohio.

He served as Secretary of State of Ohio from January 8, 1923, to January 10, 1927.

From April 1927 to February 1928, he was President of the Cleveland Radio Broadcasting Corporation, managing Radio Broadcast Station WJAY.

He became Chief Counsel of the Federal Power Commission September 13, 1929, and resigned December 16, 1929, to become General Counsel of the Federal Radio Commission. He resigned this office to become a member of the Federal Radio Commission March 28, 1932.

On April 25, 1933, he was elected Vice Chairman of the Federal Radio Commission.

Colonel Brown is a member of the following—

American, Federal and Ohio State Bar Associations.

American Academy of Political and Social Science.

Executive Committee, American Section, International Committee on Radio.

American Legion of Ohio.

He is a Presbyterian; 32nd Degree Mason, and a Member of the Shrine.

He is married and has one son, Thad, Jr., 17 years of age.

Paul Atlee Walker

PAUL ATLEE WALKER was born January 11, 1881. He is of Virginia Quaker stock, which migrated from that State early in the 19th Century.

He graduated from the University of Chicago in 1909 with the degree of PH.B., and from the University of Oklahoma, Law Department, in 1912, with the degree of LL.B. He was for three years Principal of the Shawnee, Oklahoma, High School. For three years thereafter he was an Instructor on the Faculty of the

University of Oklahoma. He has lived continuously in Oklahoma since 1905.

From 1912 to 1915, Mr. Walker practiced law at Shawnee, Oklahoma. For more than 15 years he was connected with the State Corporation Commission of Oklahoma, serving as Counsel and Commissioner. He was elected to the Corporation Commission by popular vote and Chairman of the Commission by vote of the Commission in January, 1931, serving in that capacity until July 11, 1934, when he became a member of the Federal Communications Commission by appointment of President Roosevelt for a term of five years.

In 1919 Mr. Walker was appointed Referee by the Supreme Court of Oklahoma, under a statute which provided assistants to the Court to enable the Court to dispose of accumulated undecided cases. In this capacity he served till 1921, preparing opinions in cases which were referred to him by the Court. He was highly commended for this work.

At the conclusion of his services with the Supreme Court of Oklahoma, he resumed his work as Special Counsel for the State Corporation Commission. As such counsel he was engaged continuously in the conduct of important litigation before the Corporation Commission of Oklahoma, the Interstate Commerce Commission and in Federal Courts. He represented the State of Oklahoma in rate litigation and proceedings which brought about a reorganization of the Oklahoma rates on grain, cotton, livestock, petroleum and other important commodities. He also instituted and conducted the Consolidated Southwestern Cases, so-called, in which important rate reductions for the Southwest were obtained.

Public utility investigations initiated by Mr. Walker while serving as Chairman of the Corporation Commission of Oklahoma, and handled by him during his administration, included a general investigation of natural gas, electric light and power, telephone and cotton gin rates. He is the author of the report of the Corporation Commission in the Lone Star investigation affirmed by the State Supreme Court of Oklahoma, July 10, 1934.

In the important Rate Investigation carried on by the Interstate Commerce Commission under the Hoch-Smith Resolution, he was Chairman of the Legal Committee, representing the Southwestern State Commission and Shippers' organization.

He served as Chairman of the Committee on Corporation with the Interstate Commerce Commission in the National Association of Railroad and Utilities Commissioners from 1925 until appointed a member of the Federal Communications Commission. He was a member of the

Executive Committee of the Association and a member of its Committee on Legislation.

Mr. Walker was commissioned Major of the Oklahoma National Guard in 1918, and served as Judge Advocate General with the rank of Lieutenant Colonel of the Oklahoma National Guard during the period, 1919 to 1934.

His College Fraternities are: Sigma Alpha Epsilon (Social), Phi Delta Phi (Legal), and Delta Sigma Rho, (Debating and Oratorical).

He is a member of the following lodges:

Oklahoma City Lodge No. 36, A. F. & H.

Cyrus Chapter No. 7, R.A.M.

Bethlehem Commandery No. 45,

India Temple A.A.O.N.M.S. of Oklahoma City.

National Sojourners, Oklahoma City Chapter No. 43.

In politics Mr. Walker is a Democrat.

He is a member of the First Presbyterian Church of Oklahoma City, and has been a member of the Session of that church for several years. He is also a member of the Y.M.C.A. there.

He is a member of the Men's Dinner Club of Oklahoma City, a prominent public affairs and social organization.

Mr. Walker married Myra Evelyn Williams on June 2, 1914, at Durant, Oklahoma. They have four children, two sons and two daughters.

Dr. Irvin Stewart

Born at Fort Worth, Texas, October 27, 1899.

Graduated from Fort Worth High School.

Attended University of Oklahoma Law School, 1917-1919.

Received Degree of LL.B. from the University of Texas, 1920, and was admitted to the bar in Texas the same year.

Received A.B. and A.M. degrees, University of Texas, 1922.

Served on the faculty of the Department of Government at the University of Texas from 1922 to 1926, except for one year residence at Columbia University; subjects taught were constitutional law and international law.

Received PH.D. from Columbia in 1926.

Served as Assistant Solicitor in the United States Department of State, Washington, June 1926 to January 1928.

Returned to the faculty of government at the University of Texas from February 1928 to June 1929.

Became head of the Department of Government at the Graduate School of the American University, Washington, September, 1929.

Entered the Treaty Division of the Department of State on October 1, 1930, and served as expert on communication matters in the Department until July 10, 1934.

Was a member of the American

When Choosing a Radio School

Consider RCA Institutes . . . 25 years old . . . an institution recognized as an important factor in the radio industry.

The beginner who seeks instruction in any branch of radio will find courses designed for him . . . either at the Resident Schools in New York and Chicago or the RCA Institutes Home Study courses.

Students attending our Chicago School now have an added advantage in combining a study of the scientific wonders of the World's Fair.

FEATURES OF RCA INSTITUTES HOME STUDY COURSES

Extension courses for home study on convenient "no obligation" plan. Examination and technical advisory services. Free post graduate practical training at resident school with modern equipment under instructing engineers.



Write for Catalog

RCA Institutes, Inc.

Dept. SR-31

75 Varick Street, New York
1154 Merchandise Mart, Chicago

HOW TO LEARN

CODE

Thousands of operators agree no "system" of printed sheets can teach you the Code. TELEPLEX has taught Code to more operators in past 10 years than all other methods combined. YOU can learn Code or step up your w.p.m. amazingly this sure way. No experience needed. Beginners, amateurs, experienced ops get ahead faster with Teleplex. It doesn't merely "show" you code. IT IS Code! You actually HEAR dots-dashes any speed you want. Sends you practice messages and SENDS BACK your own key work, which no other system can do for quicker license find out about the better way used by U. S. Army, Navy, R. C. A., A. I. & T. and many others. We give you complete course, lend all equipment, give personal service on MONEY-BACK GUARANTEE. Low cost, easy terms. Without obligation write for booklet S. R. 22.

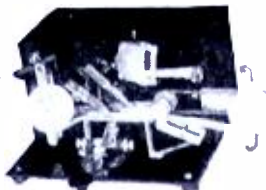

TELEPLEX COMPANY

76 Cortlandt Street

New York, N. Y.



LEEDS

is Headquarters for many of the best products in Amateur Radio.

Some of the well known brands we carry a complete line of are as follows:

General Radio—National Sylvania—Aerovox Flechthem—Acme Delta Weston-Jewell—Amertran Tripplett—Readrite Lynch—Birnbach Sprague—Cornell Dubilier Thordarson—Leichner and a large line of LEEDS products.

The Radio Amateur has found it convenient to shop at LEEDS. Only quality merchandise at wholesale prices.

We do not publish a catalog, quotations on all short wave equipment furnished by return mail.



45-G Vesey St., New York City

New York Headquarters for Short Wave and Experimental Apparatus

"SIGNAL HOP"

Beyond Your Fondest Hopes with PEAK Pre-Selector and Pre-Amplifier

With High Gain Regenerative Feature

Here's the last word in Pre-amplification employing 2 tuned stages of high gain 58 type tubes. Hundreds of tests have proved that signals of R3 to R5 audibility can be consistently boosted to R9 and R9+. Besides tremendous signal gain, PEAK gives increased sensitivity; ABSOLUTE REJECTION OF IMAGE OR REPEAT SPOTS; reduction of background noise and increased selectivity.

Operates with any S.W. or All-Wave receiver. Comes complete with 3 SETS OF BUILT IN COILS (NONE TO PLUG IN) covering all frequencies with overlap from 14-200 M. Other features include airplane type dial, smooth regeneration, automatic change-over switch, self-

contained filament supply, etc. Every PEAK Pre-Selector sold with an UNCONDITIONAL GUARANTEE of satisfaction or your money back after 15 days' trial. Hams and Short Wave fans don't delay getting all the facts today!

EASTERN RADIO SPECIALTY CO.

Manufacturers of PEAK PRODUCTS

113 East 168th Street Dept. R-104 New York, N. Y.

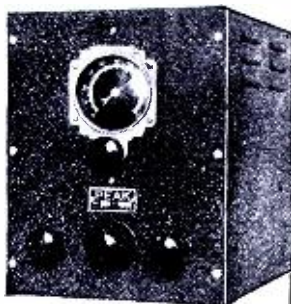

110-120 V. A.C. 50-60 cycle.

DISCOUNT

The price of the PEAK Pre-Selector is \$33 complete, less tubes. A discount of 40% applies when purchased from your jobber or favorite Mail Order House . . . or write us direct for name of nearest dealer.

A Useful Directory

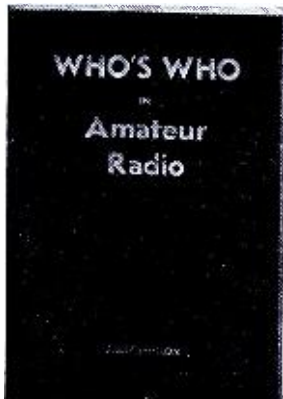

Who's Who in Amateur Radio will prove interesting to active transmitting amateurs who want to know something about the equipment and personal history of operators they contact over the air. About 3000 amateurs are listed. Photographs of some of them are included in the write-ups, which are brief but to the point.

The back of the book contains a list of the outstanding radio clubs of the United States, the United States radio inspection districts by states and countries, the International abbreviations and a condensed schedule of press, weather, and time transmissions by commercial stations.

WHO'S WHO IN AMATEUR RADIO, 6½ by 9½ inches, 160 pages, paper covers.
Price, \$1.00, postpaid.

Standard Publications, Inc.

192 Lexington Ave.,
New York, N. Y.

Make the world your neighbors with the famous DX3

INTERNATIONAL SHORT WAVE RECEIVER

Radio's Most Sensational Value

• Excels in performance and selectivity. England, France, Spain and Germany received with perfect tone quality. This remarkable all wave receiver can be built in one hour.

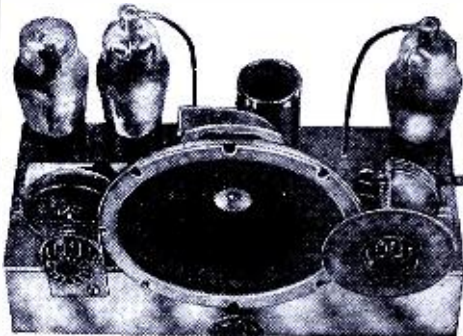

A.C.-D.C. SELF POWERED

Complete Kit

with built-in speaker, large diagram and coils to cover 14-200 meters. Tubes used: one type 6D6 pentode detector; one type 38A power pentode amplifier and one type 25Z5 voltage doubler rectifier. Extra for wiring . . . \$1.80
Kit of matched Arcturus Tubes 2.75
Broadcast coil, 200 to 500 meters .75
Special black crackled finish metal cabinet for the DX3 International 1.95

\$9.75

EXPERIMENTAL RADIO LABS

168 L. Washington St. New York, N. Y.

Every Service Man and Set Builder NEEDS This New Book "SERVICING SUPERHETERODYNES"

by John F. Rider

The superheterodyne circuit is now so universally used for receivers of the regular broadcast, all-wave, dual-wave and straight short-wave types that every radio experimenter should become intimately acquainted with its functioning. This new book by John F. Rider, who is recognized as the country's leading service expert, is a really marvelous treatise on the most interesting and most complicated of all radio hook-ups. Although intended primarily for service men, it makes absorbing and instructive reading for every short-wave constructor. It is written in the straightforward, understandable style that has made the author internationally famous, and explains all those puzzling details of "super" operation that have been bothering you for years.

Illustrated with dozens of diagrams of modern commercial receivers, from which you can get some good ideas for your own set.

278 pages, hard board covers, 5 x 7¾ inches. A big value for only

\$1.00 postpaid

Order from

STANDARD PUBLICATIONS, INC., 192 LEXINGTON AVENUE, NEW YORK, N. Y.

delegation to the International Radio Conference, 1927; International Technical Consulting Committee on Radio Communication, Copenhagen, 1931; Pan American Commercial Conference, Washington, 1931; International Radio Conference, Madrid, 1932; International Telegraph Conference, Madrid, 1932; North and Central American Regional Radio Conference, Mexico City, 1933.

Was a member of the Interdepartmental Committee on Communications, and worked with the congressional committees in drafting the bill creating the Federal Communications Commission.

Is the author of one book, "Consular Privileges and Immunities," Columbia University Press, 1926, and the editor of a volume on radio published in the Annals of the American Academy of Political and Social Science in 1929.

Is a contributor to various legal periodicals.

Married and has one son nine months of age.

Norman Stanley Case

NORMAN STANLEY CASE was born in Providence, R. I., October 11, 1888. He is of Colonial and Mayflower ancestry, his forbears coming to Rhode Island to settle with Roger Williams.

He attended the public schools in Providence, graduating from Federal St. Grammar School in 1900; Classical High School in 1904. He received his A.B. degree from Brown University in 1908. He spent 1908-1909 in travel around the world. He attended Harvard Law School from 1909-1911, then Boston University Law School 1911-1912, and received his LL.B. degree from the latter institution in 1912.

He then practiced law in Rhode Island, having been admitted to the Rhode Island Bar in 1911, and the Massachusetts Bar in 1912. He was admitted to practice before the Supreme Court of the United States in 1923. He served in the Providence City Council from 1914-1918, although his term in that body was interrupted by his military service.

He enlisted in the Massachusetts National Guard as a private in 1909 when in law school, and rose from that rank through corporal, sergeant, 1st sergeant to a Second Lieutenant of Cavalry, Massachusetts Squadron in 1912, and 1st Lieutenant in 1913. In 1915 he transferred from the Massachusetts National Guard to the Rhode Island National Guard and became 1st Lieutenant of Troop A., 1st Rhode Island Cavalry, with which organization he served on the Mexican Border in 1916.

In 1917, as Captain of Co. A, 103rd Machine Gun Battalion, 26th (Yankee) Division, he went to France in October of that year, and served with that Division until he was made a General Staff Officer, serving under Major General James G. Harbord. He was honorably dis-

charged from the Army in July 1919. He received the decoration of Chevalier de L'Etoile Noir from the President of France.

He served as a Member of the Soldiers Bonus Board of Rhode Island from 1920-1922, which was the Board that distributed the State Bonus to Rhode Island men who served in the World War.

He was appointed U. S. Attorney for the District of Rhode Island in 1921 by President Harding, and served until 1926. In the fall of 1926 he was elected Lieutenant Governor of Rhode Island and succeeded to the Governorship in February 1928, upon the death of Governor Pothier. He was subsequently elected Governor in 1928 and re-elected in 1930, serving until January 1933. His service as Governor extended over a period of five years.

He was Chairman of the Executive Committee of the Governors' Conference of the United States 1930-1932, of which Committee President Roosevelt was a member.

Governor Case received the honorary degree of Doctor of Laws from Manhattan College in 1930, and from Rhode Island State College in 1931. He is a Member of the First Baptist Church of Providence and a 32nd degree Mason. He is a Colonel in the Reserve Corps of the U. S. Army, commanding the 315th Cavalry.

Governor Case was married in 1916 to Emma Louise Arnold, of Bethel, Vermont, and they have three children, Norman Stanley, Jr. (1917); John Warren 2nd (1921), and Elizabeth Richmond (1924).

During his term as Governor, the State of Rhode Island reduced her indebtedness each year. He was the first Governor of the State to appoint Superior Court and District Court judges, the change in the law being made upon his recommendation. The Unemployment Relief Act was also passed during his administration.

METHODS FOR IMPROVING Short Wave Reception

Send for **FREE** 16 Page Booklet

POSTAL RADIO
135-N LIBERTY STREET NEW YORK, N. Y.

POSTAL SW BOOSTER GUARANTEED TO IMPROVE SHORT WAVE RECEPTION 100%

The POSTAL BOOSTER increases the sensitivity and selectivity of any Short or All-Wave receiver tremendously. It eliminates repeat spots, image frequencies and lowers the background noise considerably.



The POSTAL BOOSTER is a self powered 3-tube two-stage Tuned R. F. pre-selector and Booster that will operate on any Short or All-Wave receiver, regardless of the make or price you paid. Simple to install. Simple to operate. Each instrument is sold with a 10-day trial and money back guarantee. Write for special offer to SWR readers.

← SEND FOR FREE 16 PAGE BOOKLET

POSTAL RADIO
135-N LIBERTY ST. NEW YORK, N. Y.

He is a member of the American Legion; Veterans of Foreign Wars; State Commander of the Military Order of Foreign Wars, various Patriotic Societies.

Hamson Gary

HAMSON GARY was born in Tyler, Texas, April 23, 1873. His father, Franklin Newman Gary, a native of South Carolina, was a distinguished lawyer. Mr. Gary comes of Colonial stock on both sides of his house, and his forebears saw service in the American Revolution. His great-grandfather was a General in the War for Independence.

Mr. Gary was educated at Bingham School, N. C., and the University of Virginia, and is a member of Phi Beta Kappa and Alpha Tau Omega of the latter institution. He was captain of U. S. Volunteers in the Spanish-American War and later was colonel of the Third Infantry regiment of Texas. He was a member of the Texas House of Representatives, serving on the Judiciary and Finance Committees, and was nominated presidential elector for the state-at-large in 1908 but declined the honor. He was made a regent of the University of Texas.

ONE REASON WHY



The TRIMM FEATHERWEIGHT phones will bring in weaker signals. The Trimm cobalt steel magnet when compared with the magnet of another well known and widely accepted phone on a demagnetizing test, showed but one

half the percentage of loss in strength as the other magnet.

For better DX use Trimm Featherweight phones.

Buy from your local dealer

TRIMM RADIO MFG. CO.

1528 Armitage Ave. Chicago, Ill.

IN STOCK NATIONAL

- at Allied Radio
- Hammarlund
- at Allied Radio
- BLILEY
- at Allied Radio
- THORDARSON
- at Allied Radio
- de Forest
- at Allied Radio
- JOHNSON

and all other standard Amateur lines. Whatever your wants, we can supply them quicker and better at ALLIED, at consistently lower prices. The thing to do O.M., is to write today for the new 1935 ALLIED Catalog which is yours for the asking.

Allied Radio

833 W. Jackson Blvd., Chicago, Dept. L

Please send me your Free 1935 Catalog with the Radio Amateur Listing.

YOUR CATALOG

Name.....

Address.....

City.....



ALAN STILL LEADS! WITH THE INTERNATIONALE AND THE PRIZEWINNER.

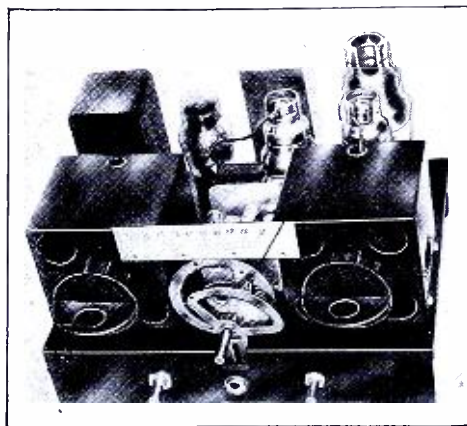

Alan Internationale
T.R.F. Circuit AC-DC Power Supply
Front Panel Plug-in Coils
Available for 110 v. A.C.—D.C. S. W. 15—200 meters, also 220 v. A.C.—D.C., 2 and 6 v. battery operation, four tubes 1-6F7, 1-78, 1-25Z5. Completely shielded in black crackle, hinged cover, metal cabinet.
Complete including 4 pairs of coils, 15-200m \$24.95
Set Areturus tubes 4.95
Complete Kit with Blueprints 21.25

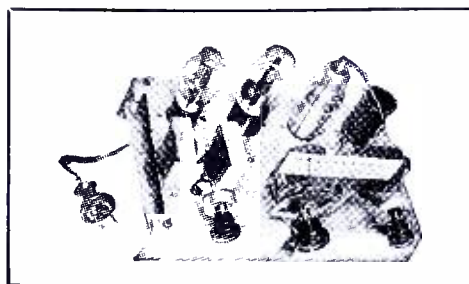

PRIZEWINNER
A.C.—D.C. S.W. (15 to 200 meters)
Completely self powered, latest type 77-43 and 25Z5 Tubes. Provision for Head Phones and Speaker. Complete, less tubes, in rich crackle-finish cabinet. Assembled, wired, tested, ready to plug in, including four coils..... \$12.95
Kit of RCA or Areturus Tubes to match.. 3.75
Complete Kit of parts, including 4 coils.. 10.55

ALAN RADIO CORP.,

Write for Free Catalog and Short Wave List.

Save time on Western shipments by buying from our Pacific Coast Branch:

1028 SOUTH OLIVE ST., LOS ANGELES, CALIF.

83 CORTLANDT ST. Dept. 10SW. N. Y. CITY

have
SHORT WAVE RADIO
sent directly
to your home

If your local newsdealer does not carry a large stock of national magazines, you will find it much more convenient — and a little cheaper, too — to have SHORT WAVE RADIO sent directly to your home or office. A year's subscription costs only \$2.50 (\$3.00 in Canada and foreign countries), and your copies will reach you without delay. Use the handy coupon below. Post office or express money orders, bank checks and U.S. stamps accepted. Do not send coins through the mail.

Twelve issues of SHORT WAVE RADIO will bring you information and enjoyment worth many times the slight price of the magazine. Among the contributors you will find the best-known men in the short-wave field: Kruse, Worcester, Lynch, Cisin, Hinds, Lester and Shortt.

STANDARD PUBLICATIONS, INC.
 192 Lexington Ave., New York, N. Y.

Enclosed is \$..... Send me SHORT WAVE RADIO for one year, starting with the issue.

Name

No. and Street

City

State

Please write clearly

**"SOUND—IT'S FUNDAMENTALS
 AND METHODS OF
 APPLICATION"**

The use of "sound" systems of various kinds is increasing so rapidly that every radio man should familiarize himself with the different types of public address amplifiers, microphones, pick-ups and numerous other accessories now available. This excellent 60-page booklet, measuring 9 x 12 inches and printed on high grade paper, was issued originally as a piece of promotion literature by a large manufacturer, but it contains so much valuable information that we feel it is well worth its slight cost—only 25 cents, postpaid.

STANDARD PUBLICATIONS, Inc.
192 LEXINGTON AVE. NEW YORK, N. Y.

INDEX TO ADVERTISERS

Alan Radio Corporation.....	47
All Star	40
Allied Engineering Institute.....	44
Allied Radio Corporation.....	47
Books.....2nd and 3rd covers, 39, 42, 46, 47 and 48	
Eastern Radio Specialty Co.....	46
Eilen Radio Laboratories.....	44
Experimental Radio Laboratories.....	46
Hammarlund Manufacturing Company.....	39
Kruse, Robert S.....	43
Leeds	45
Lynch, Arthur H., Incorporated.....	44
McMurdo-Silver, Incorporated	3
Midwest Radio Corporation.....	4th Cover
National Company, Incorporated.....	38
National Radio Institute.....	1
Postal Radio	47
Radio & Technical Publishing Co.....	37
RCA Institute, Incorporated.....	45
RCA Victor Company.....	41
Sprague Products Co.....	43
Teleplex Company	45
Trimm Radio Mfg. Co.....	47
Wholesale Radio Service Co., Incorporated.....	41, 42

NEARLY EXHAUSTED!

The first printing of the SHORT WAVE RADIO HANDBOOK

is nearly exhausted, and there will be no further printings at the present price of ONE DOLLAR. There is a limited number of copies available at the present low price, which cannot be duplicated because of increased paper and printing costs. **BE SURE TO GET YOUR COPY NOW!**

Without doubt, the SHORT WAVE RADIO HANDBOOK is the most comprehensive compilation of practical short-wave data that has ever appeared in a single book. It is authentic, condensed, well illustrated, and contains the type of information long demanded by short-wave experimenters. Just examine the table of contents and convince yourself of this fact! Every part of the book has been carefully edited; the coil data are presented in a simple and extremely handy form; you don't have to wade through tables and charts to know exactly how many turns to put on a coil. The section on audio amplifiers suitable for s.w. sets is the most complete of its kind in print. Converters, supers, wire tables, etc., are discussed fully.

Your remittance of \$1.00 will bring the HANDBOOK directly to your home without delay. **USE THE COUPON NOW BEFORE IT IS TOO LATE!**

Standard Publications, Inc.
192 Lexington Avenue
New York, N. Y.

\$1.00
Postpaid

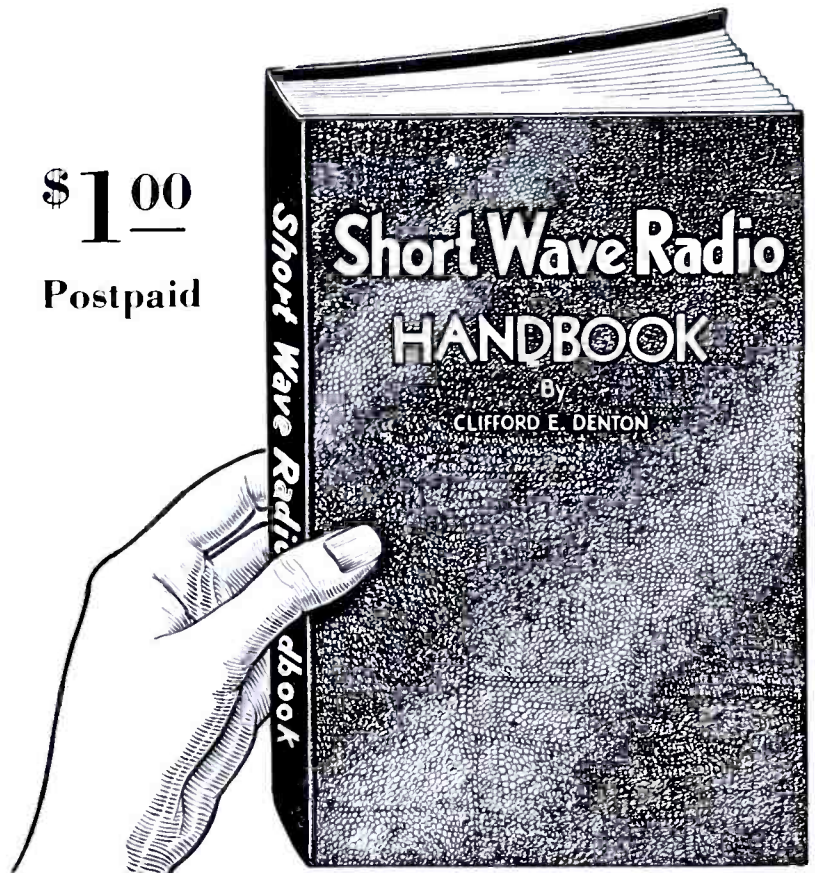

Partial Contents

Earphones, magnetic speakers, dynamic speakers, baffles and horns, loudspeaker coupling systems, turns ratio of output transformers, power sensitivity of output tubes, amplifiers, radio vs. audio amplification in s.w. receivers, audio-frequency amplifiers, audio circuit coupling considerations, detector circuits and s.w. receivers, detector tube performance curves, r.f. amplification, resistance-coupled r.f. amplifiers, transformer coupling in r.f. circuits, direct-coupled r.f. amplifiers, tuning coils and condensers, inductances at r.f., eddy currents, dielectric losses, coil capacity, fixed condensers, high-frequency bypass condensers, condensers in resistance-capacity filters, antenna circuits, reflex circuits, s.w. converters, s.w. superheterodynes, single signal reception, super-regeneration, neutralization, antennas for s.w. use, power supply units, methods of obtaining bias, power requirements, Capt. Hall's advice to s.w. listeners, ratings of condensers, resistors, etc., construction of s.w. receivers and oscillators.

Standard Publications, Inc.
192 Lexington Avenue, New York, N. Y.

Gentlemen:

Enclosed please find \$1.00 (U. S. stamps, bank check, postal or express money order accepted) for which please send me one copy of Denton's SHORT WAVE RADIO HANDBOOK. (If a dollar bill is sent, wrap it up in several layers of paper.)

Name.....

Street and number.....

City and State.....

Please print clearly

MOVIE STARS *Enthusias* OVER THE *New* 1935 MIDWEST-16



World-Wide Entertainment
Hollywood, Calif.—Until I received my new Midwest radio, I had never thought it possible to bring in entertainment from half way around the world so clearly.
Jean Harlow
 (Metro-Goldwyn-Mayer Star)



Amazing All-Wave Performance
Hollywood, Calif.—My Midwest is the best set I have ever tried. It gives me super foreign reception and new radio adventure. Its performance on all five wave bands amazes me.
RICHARD ARLEN
 (Paramount Featured Player)



Thrilling Foreign Reception
Hollywood, Calif.—Not until I tried out my Midwest 16 did I really appreciate what radio reception was. It thrills me to bring in distant foreign stations as clearly as local programs.
 (Paramount Star) *Claudette Colbert*



Better Foreign Reception
Hollywood, Calif.—I am quite enthused with my Midwest. Many friends who have heard it are delighted with its performance. It brings in, without a doubt, the finest all-wave reception I have ever heard.
Neil Hamilton

Thrill to Unequalled World-Wide Performance with this.

Amazing NEW 1935 SUPER Deluxe 16-Tube ALL-WAVE Radio

9 TO 2,400 METERS (12,000 MILE TUNING RANGE)

30 DAYS FREE TRIAL



Guaranteed WORLD-WIDE RECEPTION!

BEFORE you buy any radio, write for FREE copy of the new 1935 Midwest "Fifteenth Anniversary" catalog. See for yourself the many reasons why over 110,000 satisfied customers have bought their radios direct from Midwest Laboratories . . . and saved from 1/3 to 1/2. Learn why Midwest radios out-perform sets costing up to \$200 and more. You, too, can make a positive saving of from 30% to 50% by buying this more economical way. Why be content with ordinary so-called "All-Wave", "Dual Wave", "Skip Wave" or "Tri-Wave" receivers when Midwest gives you more wave lengths in today's most perfectly developed 16-tube Super deluxe ALL-WAVE radio that are proven by four years of success . . . that carry an iron-clad guarantee of foreign reception! These bigger, better, more powerful, clearer-toned, super selective radios have FIVE distinct wave bands; ultra short, short, medium, broadcast, and long. Their greater all-wave tuning of 9 to 2400 meters (33 megacycles to 125 KC) enables you to tune in stations 12,000 miles away with clear loud speaker reception. Write TODAY for new FREE catalog!

Now, you can enjoy super American, Canadian, police, amateur, commercial, airplane and ship broadcasts . . . and derive new delight and new excitement from unequalled world-wide performance. Now, you can enjoy the DX-ing hobby and secure verifications from more of

the world's most distant stations. Thrill to the chimes of Big Ben from GSB, London, England . . . tune in on the "Marseillaise" from FYA, Pointoise, France . . . hear sparkling music from EAQ, Madrid, Spain . . . delight in lively tangos from YVIBC, Caracas, Venezuela . . . listen to the call of the Kookaburra bird, from VK2ME, Sydney, Australia, etc. Send today for money-saving facts.

TERMS AS LOW AS \$5.00 DOWN

WORLD'S GREATEST RADIO VALUE
\$57.50 with New **Deluxe Auditorium-Type SPEAKER**
 . . . LESS TUBES . . .

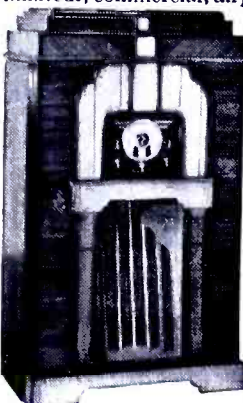

NEW STYLE CONSOLES
 The new, big, Midwest 36-page 1935 catalog pictures a complete line of beautiful, artistic de luxe consoles and classis . . . in four colors . . . a model for every purse. Hand made by master craftsmen, they harmonize beautifully with any furniture arrangement. Write for new FREE catalog today!

50 ADVANCED 1935 FEATURES

Here are a few of Midwest's superior features: Controllable Expansion of Volume-Selectivity-Sensitivity (Micro-Tenuator) . . . Fidel-A-Trol . . . Triple Calibration Plus . . . Pure Silver Wire . . . Ceramic Coil Forms . . . Separate Audio Generator . . . Simplified Tuning Guide Lights . . . Compact Synchronized Band Switch . . . Amplified Automatic Volume Control . . . 7 KC Selectivity . . . Power Driver Stage . . . 16 Latest Type Tubes . . . etc. Read about these and 38 other features in the new FREE Midwest catalog. Never before so much radio for so little money. Write for FREE catalog.

DEAL DIRECT WITH LABORATORIES

Increasing costs are sure to result in higher radio prices soon. Buy before the big advance . . . NOW! . . . while you can take advantage of Midwest's sensational values . . . No middlemen's profits to pay. You can order your radio from the new Midwest catalog with as much certainty of satisfaction as if you were to select it in our great radio laboratories. You save 30% to 50% when you buy direct this popular way . . . you get 30 days FREE trial . . . as little as \$5.00 down puts a Midwest radio in your home. Satisfaction guaranteed or money back. Write for FREE catalog.

SAVE UP TO 50%

Sign and mail coupon . . . or, send name and address on postal card . . . NOW!

Jean Harlow, Richard Arlen, Claudette Colbert, Neil Hamilton, Maureen O'Sullivan, Gloria Stuart and Ginger Rogers are some of the movie stars who prefer the Midwest radio because it gives them the super all-wave reception that they desire. Try the Midwest for thirty days before you decide. Midwest gives you triple protection with: A one-year guarantee, foreign reception guarantee, money-back guarantee.

MAIL COUPON TODAY! FOR AMAZING 30-DAY FREE TRIAL OFFER AND NEW 1935 CATALOG

MIDWEST RADIO CORP., Dept. 617 Cincinnati, Ohio.

Without obligation on my part send me your new FREE 1935 catalog, and complete details of your liberal 30-day FREE trial offer. This is NOT an order.

User-Agents Make Easy Extra Money
 Check Here for Details

Name _____
 Address _____
 Town _____ State _____

MIDWEST RADIO CORP.
 DEPT. 617 — CINCINNATI, OHIO, U. S. A.
 Established 1920 Cable Address Miraco. . . . All Codes